

The logo for ZaHo Lighting is centered on the page. It features the word "ZAHO" in a large, bold, white, sans-serif font, with a registered trademark symbol (®) to its upper right. Below "ZAHO" is the word "LIGHTING" in a smaller, white, all-caps, sans-serif font. The background is a light gray with several thick, wavy, blue lines that create a sense of motion and depth, resembling light trails or flowing liquid.

**ZAHO**<sup>®</sup>  
LIGHTING



**ZAHO<sup>®</sup>**  
LIGHTING

# table of content / spis treści

intro / wstęp	3
wall / kinkiety	17
projectors / projektory	45
tracks / szyny	63
recessed / wpuszczane	67
surface / nastropowe	109
suspended / zwieszane	137
desk and floor lamps / lampy biurkowe i podłogowe	183
outdoor / zewnętrzne	195

**made in Poland**



# light management

Zaho lighting was created out of fascination with light and its influence on the quality of life. For us, a luminaire is not only about construction and design, but above all about the quality of light, which affects human well-being. All products are designed and manufactured in a factory in Poland. We use electronic components and LEDs from the best world producers. The components supply chain is made up only of qualified suppliers with whom we have cooperated for years. We examine and test product prototypes in the laboratory before they are included in our permanent offer. Thanks to our own factory serving our group of companies, we have control over the whole production process. Many years of experience in the investment market allows us to support the investor and the architect in the implementation of the project, from the selection of luminaires, through calculations, to supervision over the implementation of the concept.

Zaho lighting powstało z fascynacji światłem i jego oddziaływania na jakość życia. Oprawa oświetleniowa to dla nas nie tylko konstrukcja i design, ale przede wszystkim jakość światła, która wpływa na samopoczucie człowieka. Wszystkie produkty są projektowane i produkowane w fabryce w Polsce. Stosujemy komponenty elektroniczne i diody LED najlepszych światowych producentów. Łańcuch dostaw komponentów stanowią jedynie kwalifikowani dostawcy z którymi współpracujemy od lat. Prototypy produktów badamy i testujemy w laboratorium zanim trafią one do stałej oferty. Dzięki własnej fabryce obsługującej naszą grupę firm, mamy kontrolę nad całym procesem produkcyjnym. Wieloletnie doświadczenie na rynku inwestycyjnym pozwala nam na wsparcie inwestora i architekta w realizacji projektu od doboru opraw, poprzez obliczenia, po nadzór nad realizacją koncepcji.



Many years of experience of our team in designing and manufacturing of luminaires guarantees that products meet the high quality requirements of customers.

Wieloletnie doświadczenie naszego zespołu w projektowaniu i produkcji opraw oświetleniowych gwarantuje, że produkty spełniają wysokie wymagania jakościowe klientów.



Before we create a project, we thoroughly analyse the wishes and needs of the client and the conditions of the space, thanks to which we are able to advise and together find the best solution for the consumer.

Zanim stworzymy projekt, dogłębnie analizujemy pragnienia i potrzeby klienta oraz warunki pomieszczenia, dzięki czemu jesteśmy w stanie doradzić oraz wspólnie znaleźć najlepsze rozwiązanie dla konsumenta.



After getting acquainted with the client's requirements and the conditions of the facility, we carefully create a project in which we take into account individual comments and jointly made decisions to meet all expectations.

Po zapoznaniu się z wymogami klienta oraz warunkami obiektu, starannie tworzymy projekt, w którym uwzględniamy poszczególne uwagi oraz wspólnie podjęte decyzje, aby spełniał wszelkie oczekiwania.



Thanks to our experts and the use of innovative technologies, the project can be carried out comprehensively. We provide technical support at every stage, as well as assistance during the start-up and programming of systems.

Dzięki naszym ekspertom oraz wykorzystywaniu innowacyjnych technologii projekt może zostać zrealizowany kompleksowo. Zapewniamy wsparcie techniczne na każdym etapie, a także pomoc podczas uruchomienia i programowania systemów.





A vertical photograph on the left side of the page shows a modern interior space. A large window looks out onto a dense forest with tall trees. A portion of a grey sofa is visible in the bottom left corner.

# 5 YEARS WARRANTY\*

**/ 5 lat gwarancji \***

\* for selected options / dla wybranych opcji

# LED

LED technology allows to obtain light of high quality and ensures extended service life. Additionally, less energy is used than when using traditional light bulbs. Thanks to LED technology, it is possible to regulate the colour temperature and dim the light. LED light sources generate light of very high power while maintaining energy efficiency.

Technologia LED pozwala pozyskiwać światło o wysokiej jakości i zapewnia wydłużony okres ich użytkowania. Dodatkowo zużywa się mniejszą ilość energii niż podczas korzystania z tradycyjnych żarówek. Dzięki technologii LED możliwa jest regulacja temperatury barwowej, a także przyciemnianie światła. Źródła światła LED generują światło o bardzo dużej mocy przy jednoczesnym zachowaniu energooszczędności.

*light-emitting diod / dioda emitująca światło*

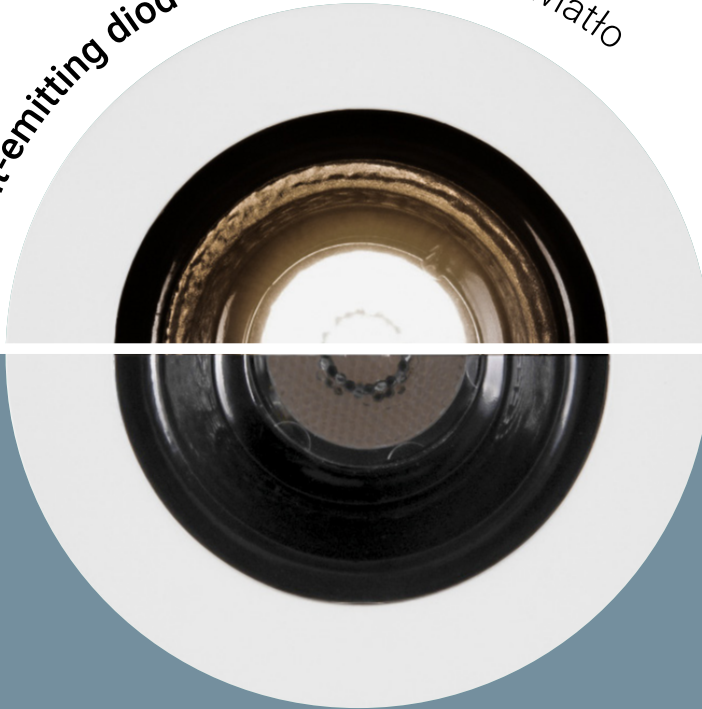

# lumen

Lumen is a unit of luminous flux and determines the amount of light emitted by a light source. The efficiency (effectiveness) of luminaire determines the ratio of the luminous flux to the power consumed by a light source.

Lumen jest jednostką strumienia świetlnego i określa ilość światła emitowanego przez dane źródło światła. Wydajność (skuteczność) danego oświetlenia, określa stosunek strumienia świetlnego do mocy pobieranej przez źródło światła.

# lux

Lux is the unit of illuminance that is used to determine the amount of light obtained in a given area. One lux is one lumen per square metre. With this unit, it is possible to measure the amount of visible light and the intensity of light in a given area.

Lux jest jednostką natężenia oświetlenia, której używa się do określenia ilości otrzymywanego światła na danym obszarze. Jeden lux to jeden lumen na metr kwadratowy. Dzięki tej jednostce możliwe jest zmierzenie ilości światła widzialnego oraz natężenie światła na danym obszarze.



100 lux



500 lux



500 lux



300-500 lux



500 lux

suggested amount of lux per 1m<sup>2</sup> / sugerowana ilość lux na 1m<sup>2</sup>

## colour temperature /temperatura barwowa

The colour of light is an important issue when selecting the lighting, which should be adjusted to the individual needs of the user, as it affects the mood and comfort of use. Cold light helps to concentrate, and with warm colours we can rest in a great way. The colour of light, which is expressed in Kelvin unit, should be adjusted to the type and purpose of the room. Warm colours are best suited to interiors such as: living room and bedroom, and cold ones to the office.

Barwa światła to ważna kwestia podczas doboru oświetlenia, która powinna być dopasowana do indywidualnych potrzeb użytkownika, ponieważ wpływa na samopoczucie oraz jego komfort. Zimne światło pomaga w koncentracji, a przy ciepłych barwach odpoczywa się najlepiej. Barwa światła, którą wyraża się w jednostce Kelvin, powinna być dopasowana do rodzaju oraz przeznaczenia pomieszczenia. Ciepłe barwy najlepiej sprawdzą się we wnętrzach takich jak: salon i sypialnia, a zimne w biurze.

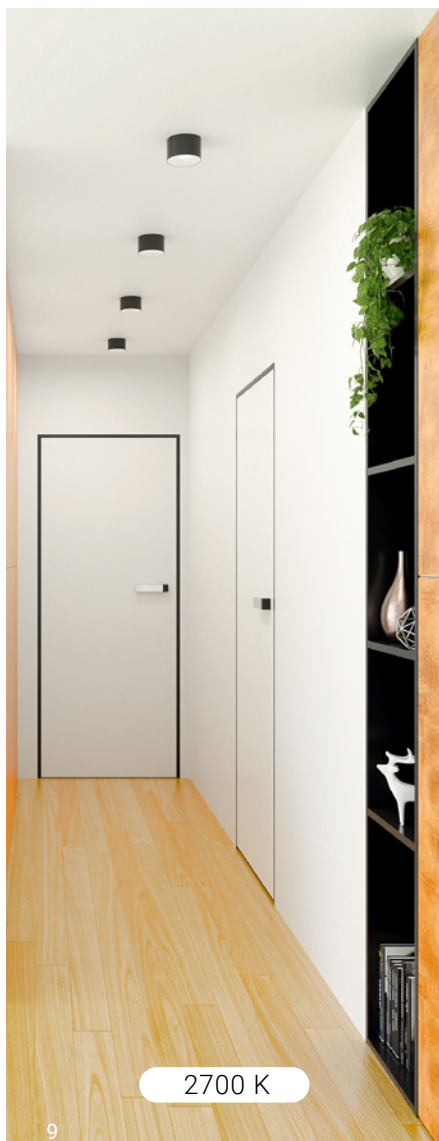

# CRI > 90

CRI is a factor that allows you to determine how the light affects the perception of colours in a room. The reference to which the light sources are matched is CRI equal to 100, which is the same as for sunlight. It is very important to ensure that the perception of objects in artificial light is as close to daylight as possible. Such a procedure improves the appearance of the interior and gives it a unique character.

CRI jest współczynnikiem, który umożliwia określenie sposobu, w jaki padające światło wpływa na postrzeganie barw w pomieszczeniu. Odnośnikiem, do którego dopasowuje się źródła światła, jest CRI równe 100, czyli takie same jak w przypadku światła słonecznego. Bardzo ważnym przy doborze oświetlenia do wnętrza jest zwrócenie uwagi, aby postrzeganie obiektów w sztucznym świetle było jak najbardziej zbliżone do światła dziennego. Taki zabieg poprawia wygląd wnętrza i nadaje mu wyjątkowego charakteru.



CRI > 50



CRI > 80



CRI > 90

# tunable white

The Tunable White lighting control system allows you to match the right amount and colour of light to all rooms of the house, so that working and staying in it becomes as efficient and comfortable as possible. The system smoothly adapts to the natural rhythm of daily light, which has a positive impact on the psychological comfort of a person. The solution is selected individually according to consumer needs. The system can be configured or set for a required period of time.

System sterowania oświetleniem Tunable White pozwala na dopasowanie odpowiedniej ilości oraz barwy światła do wszystkich pomieszczeń domu, tak aby praca i przebywanie w nim stały się jak najbardziej wydajne i wygodne. System płynnie dopasowuje się do naturalnego rytmu dobowego światła, co pozytywnie wpływa na komfort psychiczny człowieka. Rozwiązanie jest dobierane indywidualnie do potrzeb konsumenta. System może być konfigurowany bądź ustawiony na wymagany czas.

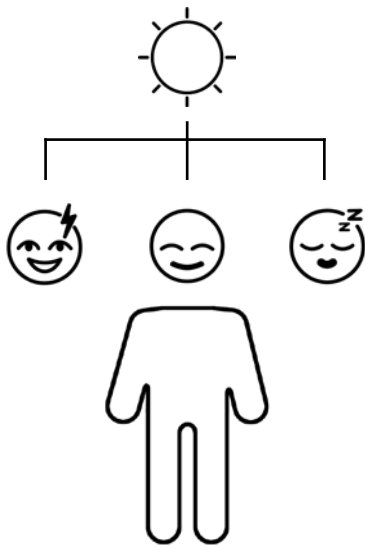

more energy  
więcej energii

improved mood  
poprawa nastroju

better sleep  
lepszy wypoczynek

Thanks to the illumination of Tunable White, the daily rhythm of a human being is kept in the right tone. It has been proven that natural light allows for higher efficiency, cool colours of light influence the production of melatonin and, in combination with high intensity, increase the level of human concentration. Research proves that such a comprehensive selection of light can improve work efficiency, but also be a therapy in treating patients with various health problems.

Dzięki oświetleniu w systemie Tunable White rytm dobowy człowieka zachowany zostaje w odpowiedniej tonacji. Udowodniono, że światło naturalne pozwala na większą wydajność, chłodne barwy światła wpływają na produkcję melatoniny, a w połączeniu z wysoką intensywnością zwiększają poziom skupienia człowieka. Badania dowodzą, że taki kompleksowy dobór światła może poprawić efektywność pracy, ale również być terapią w leczeniu pacjentów o różnych problemach zdrowotnych.

# casambi

Casambi Lighting Control allows for comprehensive control of all lighting units. Users of the system can freely change the colour of the light, modify the colour temperature of the luminaire and create the light that suits different occasions. The system, equipped with appropriate sensors, is able to adjust the amount and quality of light needed to the time of day. This solution is perfect for both residential, offices and other professional projects.

Sterowanie oświetleniem Casambi pozwala na kompleksową kontrolę wszystkich elementów oświetlenia. Użytkownicy systemu mogą swobodnie zmieniać kolor światła, modyfikować temperaturę barwową oprawy i kreować światło dobrane do różnych okazji. System wyposażony w odpowiednie czujniki jest w stanie sam dopasować ilość i jakość potrzebnego światła do pory dnia. To rozwiązanie doskonale sprawdzi się zarówno w mieszkaniach, biurach jak i w innych profesjonalnych projektach.

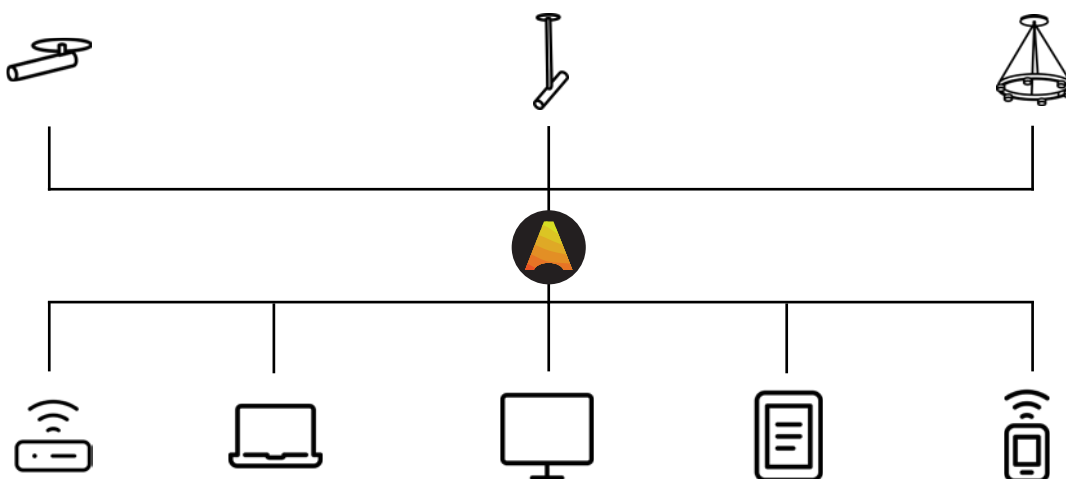

**configuration  
of the number  
/ konfigurowanie  
numeru**

1 2 3 4 E K C L

mounting type / rodzaj montażu

electronics / elektronika

colour temperature / temperatura barwowa

finishes / wykończenia

optics / optyka

W	wall / kinkiet
R	recessed / wpuszczane
M	surface / nastropowe
S	suspended / zwieszane
D	desk lamps / lampy biurkowe
F	floor lamps / lampy podłogowe
K	projectors / projektory
T	track system / szyna

O	ON/OFF
D	DALI
C	CASAMBI

27	2700K
30	3000K
40	4000K
TW	Tunable White

01	white / biały
02	black / czarny
03	grey / szary
04	gold / złoty
05	white outside / black inside   biały zewnętrzny / czarny wewnętrzny
06	black outside / white inside   czarny zewnętrzny / biały wewnętrzny
07	black outside / gold inside   czarny zewnętrzny / złoty wewnętrzny
08	gold outside / black inside   złoty zewnętrzny / czarny wewnętrzny
09	grey outside / black inside   szary zewnętrzny / czarny wewnętrzny
10	black outside / grey inside   czarny zewnętrzny / szary wewnętrzny
11	brass / mosiądz
12	black outside / brass inside   czarny zewnętrzny / mosiądz wewnętrzny









60	55	51	50	40	36	30	25	20	17	12	10
60°	55°	51°	50°	40°	36°	30°	25°	20°	17°	12°	10°



## icons / ikony

	resistance class IP / klasa odporności IP
	EU declaration of conformity / zgodność UE
	power supply 220-240 / zasilanie 220-240
	light source not included / źródło światła niedołączone
	insulation class I / klasa szczelności I
	insulation class II / klasa szczelności II
	insulation class III / klasa szczelności III
	profile size / wymiar profilu
	mounting hole / otwór montażowy

## finishes / wykończenia

	01 white / biały
	02 black / czarny
	03 grey / szary
	04 gold / złoty
	11 brass / miedź
	05 white outside / black inside   biały zewnętrzny / czarny wewnętrzny
	06 black outside / white inside   czarny zewnętrzny / biały wewnętrzny
	07 black outside / gold inside   czarny zewnętrzny / złoty wewnętrzny
	08 gold outside / black inside   złoty zewnętrzny / czarny wewnętrzny
	09 grey outside / black inside   szary zewnętrzny / czarny wewnętrzny
	10 black outside / grey inside   czarny zewnętrzny / szary wewnętrzny
	12 black outside / brass inside   czarny zewnętrzny / miedź wewnętrzny

We reserve the right to withdraw and change products from the catalogue at any time without prior notice. The colour options presented in the catalogue may differ from the actual ones. Power may vary depending on the LED performance of the particular generation. Technical parameters are subject to change. For each luminaire the value of luminous flux is given from the luminaire.

Zastrzegamy prawo do wycofania produktów z katalogu lub zmian, w każdej chwili i bez wcześniejszego poinformowania. Opcje kolorystyczne wykończeń przedstawione w katalogu mogą różnić się od rzeczywistych. Moc może się różnić w zależności od wydajności LED danej generacji. Parametry techniczne mogą ulec zmianie. Dla każdej oprawy podana jest wartość strumienia z oprawy.

# index

A	ATRO				
B	BEE				
	BERO				
	BROOKLYN				
C	CAPS				
	CLEAR EYE				
	CUP				
	CUT				
D	DROP				71, 73
E	ERO				91, 93
F	FIT				
	FIXY				
G	GALAXY	31			
H	HED				103, 105
	HEXAGON				
	HILO				77
	HOLD				97
I	IGNIS				
J	JAGO				
L	LINE				
	LUNA	33, 35, 37			
M	MILS				107
N	NEAT				69
	NOK	43			99, 101
P	PIKS				79, 81
	POP				
	POLPO				
R	RID	39, 41			95
S	SAMOS				
	SHADOW				
	SLIM				53
	SOL				
	SPEAKER				83, 85, 87, 89
	SPICY	19			
	SPRITZER				
	STAR	25, 27			
	STAR IN FULL	21, 23			
	STRAW				
	SUN				
T	TARA	29			
	TERIA				
	TIVO				75
	TORTA				
	TRACK 48V				65
	TRACK 230V				63

wall / kinkiety

projectors / projekторы

tracks / szynoprzewody

recessed / wpuszczane

**surface / nastropowe**

113

111

117, 119

125

129

115

133

127

131

121, 123

135

**suspended / zwieszane**

149

167

155

163

157

165

177

153

181

169

151

145

171

139, 141, 143

147

159, 161

179

173

175

**desk lamps / biurkowe**

185

**floor lamps / podłogowe**

189

191

187

193

**outdoor / zewnętrzne**

197



**wall / kinkiety**



# SPICY

Spicy is a luminaire with an intriguing shape. As the name suggests, it will add spice to any interior. The softly curved geometry of the light is freely suspended on the wall, which makes the luminaire light. The use of several Space luminaires in a given space gives a unique visual effect.

Spicy to oprawa o intrygującym kształcie. Jak sama nazwa wskazuje doda pikanterii każdemu wnętrzu. Miętko zakrzywiona geometria światła zostaje swobodnie zwieszona na ścianie co nadaje oprawie lekkości. Zastosowanie kilku opraw Spicy w danej przestrzeni nadaje niepowtarzalnego efektu wizualnego.

# SPICY

IP 20 CE  



## Options

Opcje

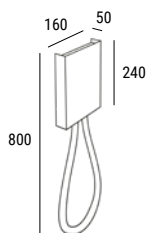

LED | 26W | 1520lm |  
CRI ≥ 90 |  
weight/waga: 3kg |  
box/karton:  
900x300x100mm |

W0021 E . K C . 0

## Finishes

Wykończenia



E	K	C
		<b>Colour / Kolor</b>
		01 - white   biały
		02 - black   czarny
		03 - grey   szary
		04 - gold   złoty
		<b>Colour temperature / Temperatura barwowa</b>
		27 - 2700K
		30 - 3000K
		40 - 4000K
		TW - Tunable White (only with Casambi/tylko w Casambi)
		<b>Electronics / Elektronika</b>
		O - ON/OFF
		D - DALI
		C - CASAMBI



# STAR IN FULL

Star in full is a luminaire that will become a real star in any space. Discreet light hidden in the body of the luminaire subtly illuminates its center. The golden finish gives the frame an elegant and rich chic in moderation.

Star in full to oprawa, która stanie się prawdziwą gwiazdą w każdej przestrzeni. Dyskretne światło ukryte w korpusie oprawy, w subtelny sposób rozświetla jej centrum. Złote wykończenie nadaje oprawie eleganckiego i bogatego szyku z zachowaniem umiaru.



# STAR IN FULL

IP 20 CE  



## Options

Opcje

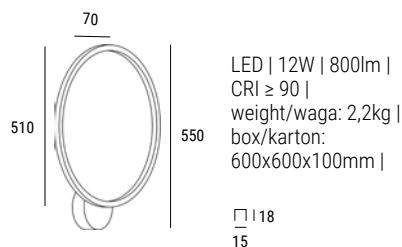

W0017 E . K C . 0

## Finishes

Wykończenia

E	K	C
		<b>Colour / Kolor</b>
		01 - white   biały
		02 - black   czarny
		03 - grey   szary
		04 - gold   złoty
		05 - white / black   biały / czarny
		06 - black / white   czarny / biały
		07 - black / gold   czarny / złoty
		08 - gold / black   złoty / czarny
		09 - grey / black   szary / czarny
		10 - black / grey   czarny / szary
		<b>Colour temperature / Temperatura barwowa</b>
		27 - 2700K
		30 - 3000K
		40 - 4000K
		<b>Electronics / Elektronika</b>
		0 - ON/OFF
		C - CASAMBI

 01 white 01 biały	 05 white outside/black inside 05 biały zewnętrzny/czarny wewnętrzny	 09 grey outside/black inside 09 szary zewnętrzny/czarny wewnętrzny
 02 black 02 czarny	 06 black outside/white inside 06 czarny zewnętrzny/biały wewnętrzny	 10 black outside/grey inside 10 czarny zewnętrzny/szary wewnętrzny
 03 grey 03 szary	 07 black outside/gold inside 07 czarny zewnętrzny/złoty wewnętrzny	
 04 gold 04 złoty	 08 gold outside/black inside 08 złoty zewnętrzny/czarny wewnętrzny	



## STAR IN FULL - BRASS

Star in full is a luminaire that will become a real star in any space. Discreet light hidden in the body of the luminaire subtly illuminates its center. The golden finish gives the frame an elegant and rich chic in moderation.

Star in full to oprawa, która stanie się prawdziwą gwiazdą w każdej przestrzeni. Dyskretne światło ukryte w korpusie oprawy, w subtelny sposób rozświetla jej centrum. Złote wykończenie nadaje oprawie eleganckiego i bogatego szyku z zachowaniem umiaru.

# STAR IN FULL - BRASS

IP 20 CE  



## Options

Opcje

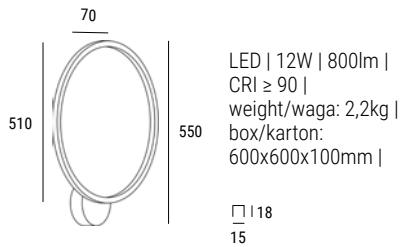

W0020 E . K 12 . 0

## Finishes

Wykończenia

 12 black outside / brass inside  
12 czarny zewnętrzny / biały wewnętrzny

E K

Colour temperature / Temperatura  
barwowa

27 - 2700K

30 - 3000K

40 - 4000K

Electronics / Elektronika

O - ON/OFF

C - CASAMBI



# STAR WL

The Star WL lamp, which will work perfectly in any interior, is innovative and unique. It will ideally fill modern spaces and give them an original feel. It has the shape of a circle, which looks perfect on its own and also with other lamps. Star will create unprecedented decoration in every house, even when it is switched off.

Lampa Star WL, która doskonale sprawdzi się w każdym wnętrzu, jest innowacyjna i nietuzinkowa. Idealnie wypełni nowoczesne przestrzenie i nada im oryginalnego wyjątku. Ma kształt okręgu, który doskonale wygląda w pojedynkę, a także z innymi lampami. Star stworzy niespotykaną dekorację w każdym domu, nawet kiedy będzie wyłączona.

# STAR WL

IP20 CE  



## Options

Opcje

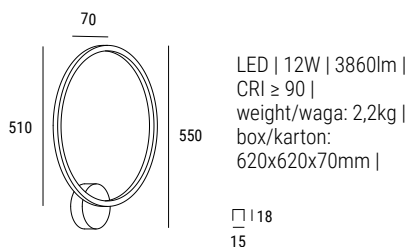

W0010 E . K C . 0

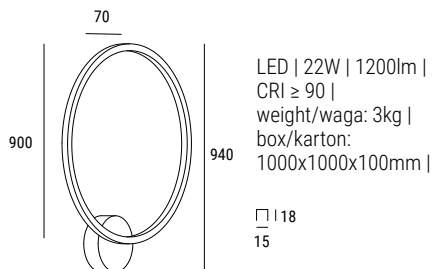

W0011 E . K C . 0

## Finishes

Wykończenia



E	K	C
<b>Colour / Kolor</b>		
01 - white   biały		
02 - black   czarny		
03 - grey   szary		
04 - gold   złoty		
<b>Colour temperature / Temperatura barwowa</b>		
27 - 2700K		
30 - 3000K		
40 - 4000K		
<b>Electronics / Elektronika</b>		
0 - ON/OFF		
C - CASAMBI		



# STAR WL1

The Star WL 1 lamp, which will work perfectly in any interior, is innovative and unique. It will ideally fill modern spaces and give them an original feel. It has the shape of a circle, which looks perfect on its own and also with other lamps. Star will create unprecedented decoration in every house, even when it is switched off.

Lampa Star WL, która doskonale sprawdzi się w każdym wnętrzu, jest innowacyjna i nietuzinkowa. Idealnie wypełni nowoczesne przestrzenie i nada im oryginalnego wyjątku. Ma kształt okręgu, który doskonale wygląda w pojedynkę, a także z innymi lampami. Star stworzy niespotykaną dekorację w każdym domu, nawet kiedy będzie wyłączona.

# STAR WL1

IP 20 CE  



## Options

Opcje

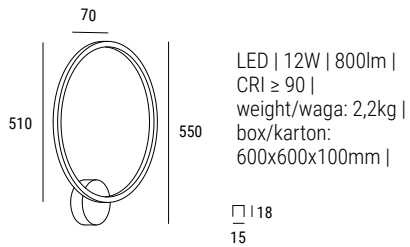

W0018 E . K C . 0

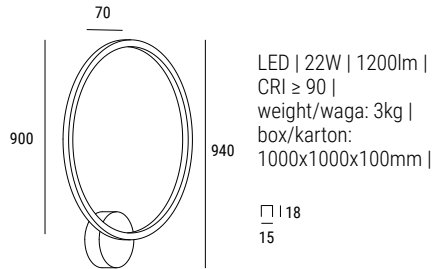

W0019 E . K C . 0

## Finishes

Wykończenia



**E K C**

Colour / Kolor

01 - white | biały

02 - black | czarny

03 - grey | szary

04 - gold | złoty

Colour temperature / Temperatura barwowa

27 - 2700K

30 - 3000K

40 - 4000K

Electronics / Elektronika

0 - ON/OFF

C - CASAMBI

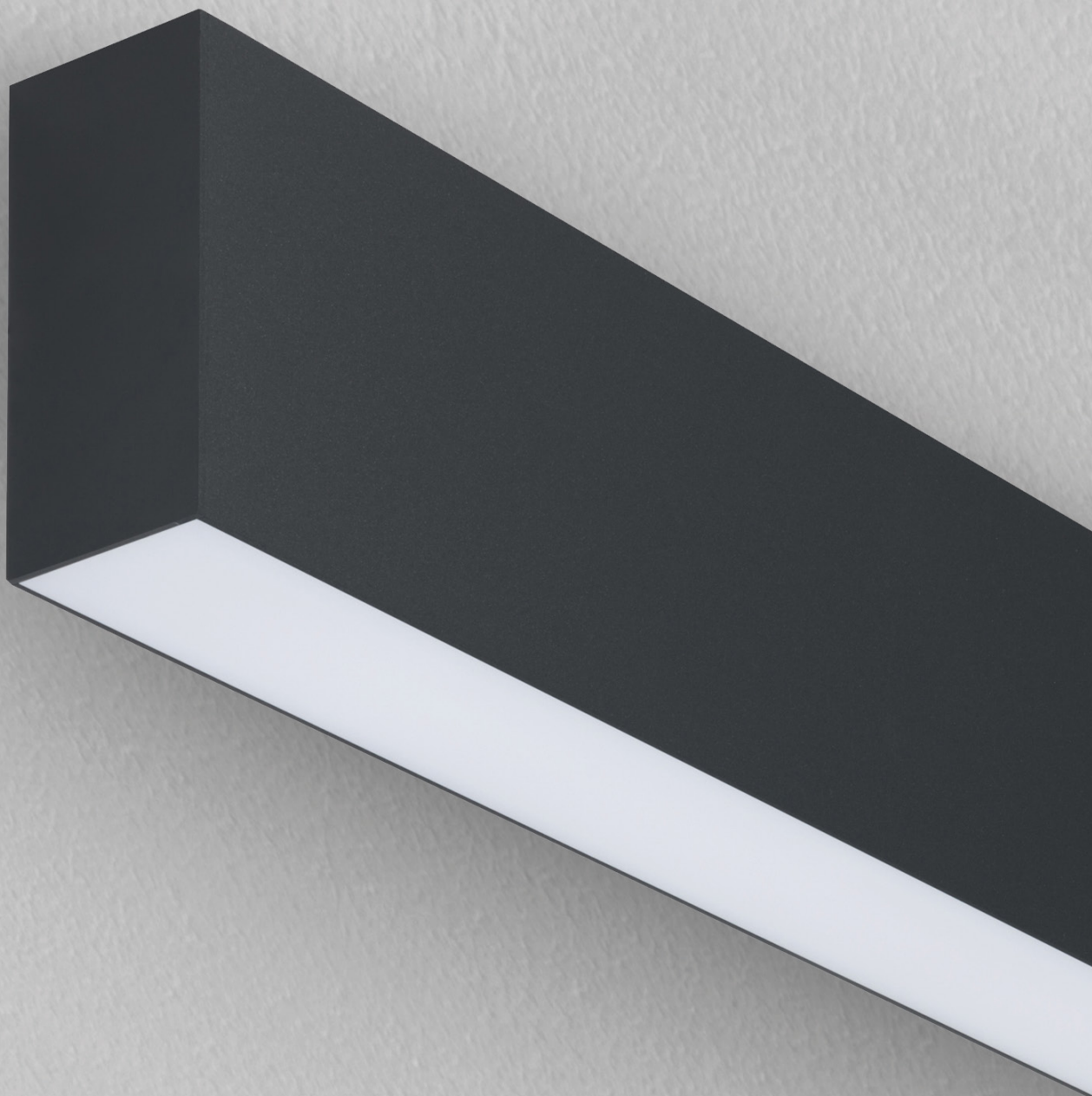

## TARA IP44

Tara minimalist, discreet design. Wall lamp with direct lighting using LED technologies. Aluminum body with the possibility of finishing it in four different colors. The ingress protection IP44 allows the luminaire to be used as indoor lighting, for example in bathrooms, and outdoor lighting - balconies.

Tara minimalistyczny, dyskretny design. Kinkiet z oświetleniem bezpośrednim wykorzystującym technologie LED. Aluminiowy korpus z możliwością jego wykończenia w czterech wariantach kolorystycznych. Klasa szczelności IP44 pozwala zastosować oprawę jako oświetlenie wewnętrzne np. łazienki oraz oświetlenie zewnętrzne – balkony.



# TARA IP44

IP44 CE  



## Options

Opcje

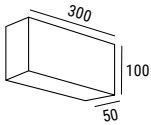

LED | 7W | 550lm |  
CRI  $\geq$  90 |  
weight/waga: 0,8kg |  
box/karton: 350x70x120mm |

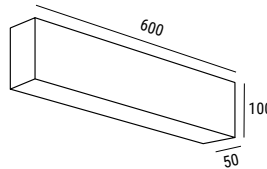

LED | 13W | 1100lm |  
CRI  $\geq$  90 |  
weight/waga: 1,5kg |  
box/karton: 650x70x120mm |

W00250 . K C . 0

W00260 . K C . 0

## Finishes

Wykończenia



E K C

Colour / Kolor

01 - white | biały

02 - black | czarny

03 - grey | szary

04 - gold | złoty

Colour temperature / Temperatura barwowa

27 - 2700K

30 - 3000K

40 - 4000K

Electronics / Elektronika

O - ON/OFF

D - DALI



## **GALAXY WL**

Galaxy WL will be the right choice for those looking for original solutions. Galaxy is a modern wall lamp with unusual form drawing attention: three round light sources form a light arch, becoming a kind of wall decoration. Using several lamps, you can easily create a light composition in the selected room.

Galaxy WL będzie odpowiednim wyborem dla tych, którzy szukają niebanalnych rozwiązań. To nowoczesny kinkiet, którego nietuzinkowa forma przykuwa uwagę: trzy okrągłe źródła światła tworzą lekki łuk, stając się swoistą ozdobą ściany. Wykorzystując kilka lamp, możesz z łatwością stworzyć świetlną kompozycję w wybranym pomieszczeniu.

# GALAXY WL

IP 20 CE  



## Options

Opcje

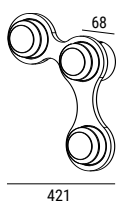

LED | 6W | 650lm |  
CRI ≥ 90 |  
weight/waga: 1,4kg |  
box/karton:  
510x510x170mm |

W0001 E . K C . 0

## Finishes

Wykończenia

E K C

### Colour / Kolor

01 - white | biały

02 - black | czarny

03 - grey | szary

04 - gold | złoty

### Colour temperature / Temperatura barwowa

27 - 2700K

30 - 3000K

40 - 4000K

### Electronics / Elektronika

O - ON/OFF

D - DALI

C - CASAMBI



01 white  
01 biały



03 grey  
03 szary



02 black  
02 czarny



04 gold  
04 złoty



## LUNA WL1

The Luna WL1 lamp is a great idea for modern interiors. It gives a gentle light that introduces a pleasant atmosphere. The round shape of Luna complements any space fantastically. It is a non-standard and innovative solution for those who appreciate the combination of functionality and aesthetics.

Lampa Luna WL1 jest świetnym pomysłem dla nowoczesnych wnętrz. Daje delikatne światło, które wprowadza przyjemny nastrój. Luna o okrągłym kształcie fantastycznie dopełni każdą przestrzeń. To niestandardowe i innowacyjne rozwiązanie dla osób ceniących sobie połączenie funkcjonalności oraz estetyki.

# LUNA WL1

IP 20 CE  



## Options

Opcje

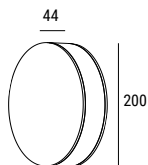

LED | 7W | 500lm |  
CRI ≥ 90 |  
weight/waga: 1,6kg |  
box/karton:  
220x220x100mm |

W00060. K C . 0

## Finishes

Wykończenia

E	K	C
		<b>Colour / Kolor</b>
		01 - white   biały
		02 - black   czarny
		03 - grey   szary
		04 - gold   złoty
		<b>Colour temperature / Temperatura barwowa</b>
		27 - 2700K
		30 - 3000K
		40 - 4000K
		<b>Electronics / Elektronika</b>
		0 - ON/OFF
		C - CASAMBI





## LUNA WL2

The symmetrical Luna WL2 lamp fills any space perfectly. It is a practical and perfectly suited solution for modern style rooms. The light provided by the lamp makes it even more cosy. Thanks to its unusual form it is an original decorative part that will attract the attention of all guests.

Symetryczna lampa Luna WL2 doskonale wypełni każdą przestrzeń. To praktyczne i idealnie trafione rozwiązanie dla pomieszczeń w stylu nowoczesnym. Światło, które daje lampa sprawia, że staje się jeszcze bardziej przytulnie. Dzięki nietuzinkowej formie jest oryginalnym elementem dekoracyjnym, który przyciągnie uwagę wszystkich gości.

# LUNA WL2

IP 20 CE  

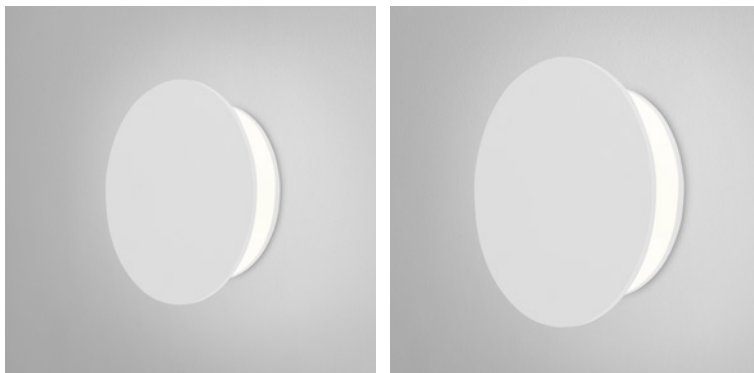

## Options

Opcje

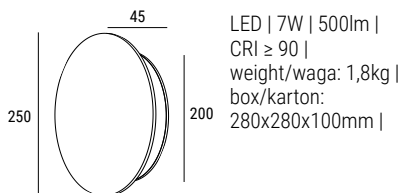
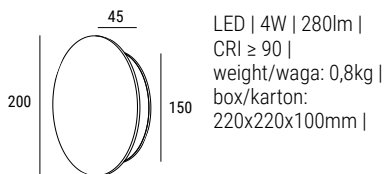

W0090. K C . 0

W008E . K C . 0

## Finishes

Wykończenia

E	K	C
<b>Colour / Kolor</b>		
01 - white   biały		
02 - black   czarny		
03 - grey   szary		
04 - gold   złoty		
<b>Colour temperature / Temperatura barwowa</b>		
27 - 2700K		
30 - 3000K		
40 - 4000K		
<b>Electronics / Elektronika</b>		
0 - ON/OFF		
C - CASAMBI		





## LUNA WL3

Luna WL3 was created with modern interiors in mind. It is a great solution for people who want to create an elegant and original space in their own home. Luna is an eye-catcher. The lamp looks great on its own and also in combination with other lamps.

Luna WL3 została stworzona z myślą o nowoczesnych wnętrzach. To świetne rozwiązanie dla osób, które pragną stworzyć elegancką i oryginalną przestrzeń we własnym domu. Luna przyciąga wzrok. Lampa doskonale wygląda w pojedynkę, a także w połączeniu z innymi lampami.



# LUNA WL3

IP 20 CE  

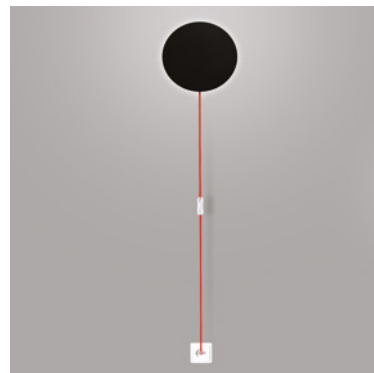

## Options

Opcje

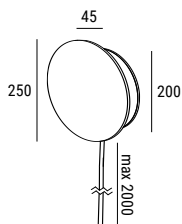

LED | 7W | 500lm |  
CRI ≥ 90 |  
weight/waga: 1,6kg |  
box/karton:  
280x280x100mm |  
wire with plug and switch/  
przewód z wtyczką i  
przełącznikiem

W0007 E . K C . 0

## Finishes

Wykończenia

E K C

### Colour / Kolor

01 - white | biały

02 - black | czarny

03 - grey | szary

04 - gold | złoty

### Colour temperature / Temperatura barwowa

27 - 2700K

30 - 3000K

40 - 4000K

### Electronics / Elektronika

0 - ON/OFF

C - CASAMBI



01 white  
01 biały



03 grey  
03 szary



02 black  
02 czarny



04 gold  
04 złoty



## RID WL2

The Rid WL2 lamp is a modern wall lamp which will fit perfectly into any space. It is available in four colour versions. Rid will look very good with other lamps.

Lampa Rid WL2 to nowoczesny kinkiet, który świetnie wpasuje się w każdą przestrzeń. Jest dostępna w czterech wersjach kolorystycznych. Rid będzie bardzo dobrze wyglądać w towarzystwie innych lamp.

# RID WL2

IP 20 CE  



## Options

Opcje

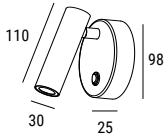

LED | 6W | 600lm |  
CRl ≥ 90 |  
weight/waga: 0,4kg |  
box/karton:  
120x120x150mm |  
switch included/  
z włącznikiem

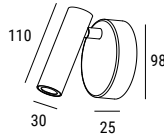

LED | 6W | 600lm |  
CR ≥ 90 |  
weight/waga: 0,4kg |  
box/karton:  
120x120x150mm |  
without the switch/  
bez włącznika

W00030. K C . L

W00130. K C . L

## Finishes

Wykończenia



## Optics

Optyka

K	C	L
<b>Optics / Optyka</b>		
20 – 20°		
36 – 36°		
55 – 55°		
<b>Colour / Kolor</b>		
01 – white   biały		
02 – black   czarny		
03 – grey   szary		
04 – gold   złoty		
<b>Colour temperature / Temperatura barwowa</b>		
27 – 2700K		
30 – 3000K		
40 – 4000K		



20°



36°



55°



## RID WL3

The Rid WL3 lamp is a wall lamp created for people who are not afraid to experiment in their interiors. It will be perfect for modern rooms. The shape and the possibility to adjust the angle of inclination of the lamp make it functional and innovative at the same time.

Lampa Rid WL3 to kinkiet stworzony z myślą o osobach, które nie boją się eksperymentować w swoich wnętrzach. Doskonale sprawdzi się w nowoczesnych pomieszczeniach. Kształt oraz możliwość regulowania kąta nachylenia reflektora sprawiają, że lampa jest funkcjonalna oraz innowacyjna jednocześnie.

# RID WL3

IP 20 CE  



## Options

Opcje

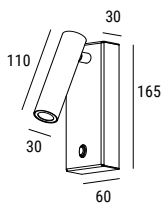

LED | 6W | 600lm |  
CRI ≥ 90 |  
weight/waga: 0,5kg |  
box/karton:  
190x190x140mm |  
switch included/  
z włącznikiem

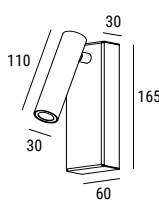

LED | 6W | 600lm |  
CRI ≥ 90 |  
weight/waga: 0,5kg |  
box/karton:  
190x190x140mm |  
without the switch/  
bez włącznika

**W00230 . K C . L**

**W00270 . K C . L**

**K C L**

### Optics / Optyka

20 – 20°

36 – 36°

55 – 55°

### Colour / Kolor

01 – white | biały

02 – black | czarny

03 – grey | szary

04 – gold | złoty

### Colour temperature / Temperatura barwowa

27 – 2700K

30 – 3000K

40 – 4000K

## Finishes

Wykończenia



01 white  
01 biały



03 grey  
03 szary



02 black  
02 czarny



04 gold  
04 złoty

## Optics

Optyka



20°



36°



55°



## NOK WL

The Nok WL lamp is a minimalist wall lamp that will look good in both modern and classic interiors. Less is more is a principle that will also work in this case. Thanks to its subtle finish, the lamp can be used in various types of rooms. It is a perfect solution for those who like simplicity.

Lampa Nok WL jest minimalistycznym kinkietem, który będzie dobrze wyglądać zarówno w nowoczesnych, jak i klasycznych wnętrzach. Mniej znaczy więcej to zasada, która sprawdzi się również w tym przypadku. Dzięki subtelnemu wykończeniu lampa może pełnić swoją funkcję w pomieszczeniach różnego typu. To doskonałe rozwiązanie dla osób, które stawiają na prostotę.

# NOK WL

IP 20 CE  



## Options

Opcje

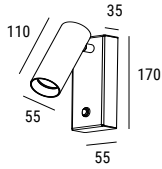

LED | 6W | 530lm |  
CRI ≥ 90 |  
weight/waga: 0,5kg |  
box/karton:  
190x190x140mm |  
switch included/  
z włącznikiem

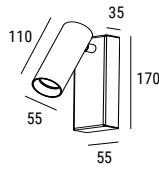

LED | 6W | 530lm |  
CRI ≥ 90 |  
weight/waga: 0,5kg |  
box/karton:  
190x190x140mm |  
without the switch/  
bez włącznika

**W00240 . K C . L**

**W00220 . K C . L**

K	C	L
		Optics / Optyka
		36 - 36°
		Colour / Kolor
		01 - white   biały
		02 - black   czarny
		03 - grey   szary
		04 - gold   złoty
		Colour temperature / Temperatura barwowa
		27 - 2700K
		30 - 3000K
		40 - 4000K

## Finishes

Wykończenia



## Optics

Optyka



36°





**projectors / projektory**  
**tracks / szynoprzewody**



## FIXY DECO

Fixy is a basic shape projector with high luminous efficiency. A suitable luminaire for use in commercial spaces, showrooms or private apartments. The luminaire is available in a version with a replaceable or integrated LED source. Mounting to a 3-surface track.

Fixy to projektor o podstawowym kształcie z wysoką wydajnością świetlną. Odpowiednia oprawa do zastosowania w przestrzeniach handlowych, salonach wystawienniczych czy prywatnych apartamentach. Oprawa dostępna w wersji z wymiennym bądź zintegrowanym źródłem LED. Montaż do szyny 3-fazowej.

# FIXY DECO

IP 20 CE  



## Options

Opcje

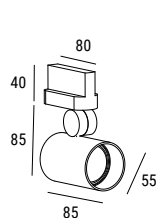

LED | GU10 | max 8W |   
weight/waga: 0,4kg |  
box/karton:  
100x100x100mm  
mounting type  
3-phase track adaptor |  
rodzaj mocowania  
szyna 3-fazowa z  
adapterem

**K00030.0 C .0**

## 3-surface track 230V

Szynoprzewód 3-fazowy 230V

accessories p. 61

akcesoria do wyboru na str. 61

## Finishes

Wykończenia

**C**

Colour / Kolor

01 - white | biały

02 - black | czarny

03 - grey | szary

04 - gold | złoty



01 white  
01 biały



03 grey  
03 szary



02 black  
02 czarny



04 gold  
04 złoty



## **FIXY 55 230V**

Fixy is a basic shape projector with high luminous efficiency. A suitable luminaire for use in commercial spaces, showrooms or private apartments. The luminaire is available in a version with a replaceable or integrated LED source. Mounting to 230V track.

Fixy to projektor o podstawowym kształcie z wysoką wydajnością świetlną. Odpowiednia oprawa do zastosowania w przestrzeniach handlowych, salonach wystawienniczych czy prywatnych apartamentach. Oprawa dostępna w wersji z wymiennym bądź zintegrowanym źródłem LED. Montaż do szyny 230V.

# FIXY 55 230V

IP 20 CE  



## Options

Opcje

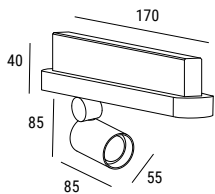

LED | 9W | 1020lm  
weight/waga: 0,4kg |  
box/karton:  
200x100x120mm  
mounting type  
3-phase track adaptor |  
rodzaj mocowania  
szyna 3-fazowa z  
adaptem

**K0011** E . K C . 0

## Track 230V

Szynoprzewód 230V

accessories p. 63  
akcesoria do wyboru na str. 63

## Finishes

Wykończenia



## Optics

Optyka



36°

E	K	C
		<b>Colour / Kolor</b>
		01 - white   biały
		02 - black   czarny
		03 - grey   szary
		04 - gold   złoty
		<b>Colour temperature / Temperatura barwowa</b>
		27 - 2700K
		30 - 3000K
		40 - 4000K
		<b>Electronics / Elektronika</b>
		O - ON/OFF
		D - DALI
		C - CASAMBI



## FIXY 48V

Fixy is a basic shape projector with high luminous efficiency. A suitable luminaire for use in commercial spaces, showrooms or private apartments. The luminaire is available in a version with a replaceable or integrated LED source. Mounting to 48V track.

Fixy to projektor o podstawowym kształcie z wysoką wydajnością świetlną. Odpowiednia oprawa do zastosowania w przestrzeniach handlowych, salonach wystawienniczych czy prywatnych apartamentach. Oprawa dostępna w wersji z wymiennym bądź zintegrowanym źródłem LED. Montaż do szyny 48V.

# FIXY 48V

IP 20 CE  

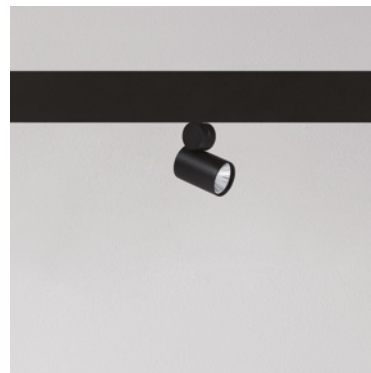

## Options

Opcje

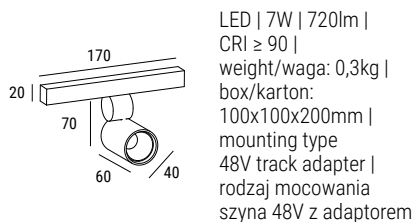

**K0005** E . K C . 36

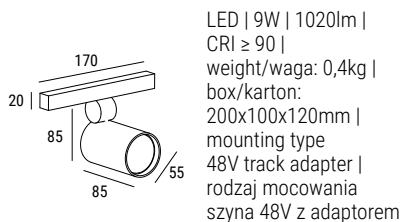

**K0004** E . K C . 36

## Track 48V

Szynoprzewód 48V

accessories p. 63  
akcesoria do wyboru na str. 63

## Finishes

Wykończenia



## Optics

Optyka



36°

E	K	C
<b>Colour / Kolor</b>		
01 - white   biały		
02 - black   czarny		
03 - grey   szary		
04 - gold   złoty		
<b>Colour temperature / Temperatura barwowa</b>		
27 - 2700K		
30 - 3000K		
40 - 4000K		
<b>Electronics / Elektronika</b>		
O - ON/OFF		
D - DALI		



## SLIM

Slim, small-sized projector designed for mounting to a 3-surface track or directly to the ceiling. The luminaire is available with a replaceable light source. Slim is perfect as accent lighting, general lighting in both residential and office spaces.

Slim projektor o niewielkich rozmiarach przeznaczony do montażu do szyny 3-fazowej lub bezpośrednio do stropu. Oprawa dostępna z wymiennym źródłem światła. Slim sprawdzi się jako oświetlenie akcentujące, oświetlenie ogólne w przestrzeniach zarówno mieszkalnych jak i biurowych.



# SLIM

IP 20 CE  



## Options

Opcje

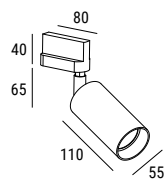

LED | GU10 | max. 8W |   
weight/waga: 0,2kg |  
box/karton:  
120x70x240mm |  
mounting type  
3-phase track adapter |  
rodzaj mocowania  
szyna 3-fazowa z  
adaptorem

K00070.0 C .0

## 3-surface track 230V

Szynoprzewód 3-fazowy 230V

accessories p. 61

akcesoria do wyboru na str. 61

## Finishes

Wykończenia

C

Colour / Kolor

01 - white | biały

02 - black | czarny

03 - grey | szary

04 - gold | złoty



01 white  
01 biały



03 grey  
03 szary



02 black  
02 czarny



04 gold  
04 złoty

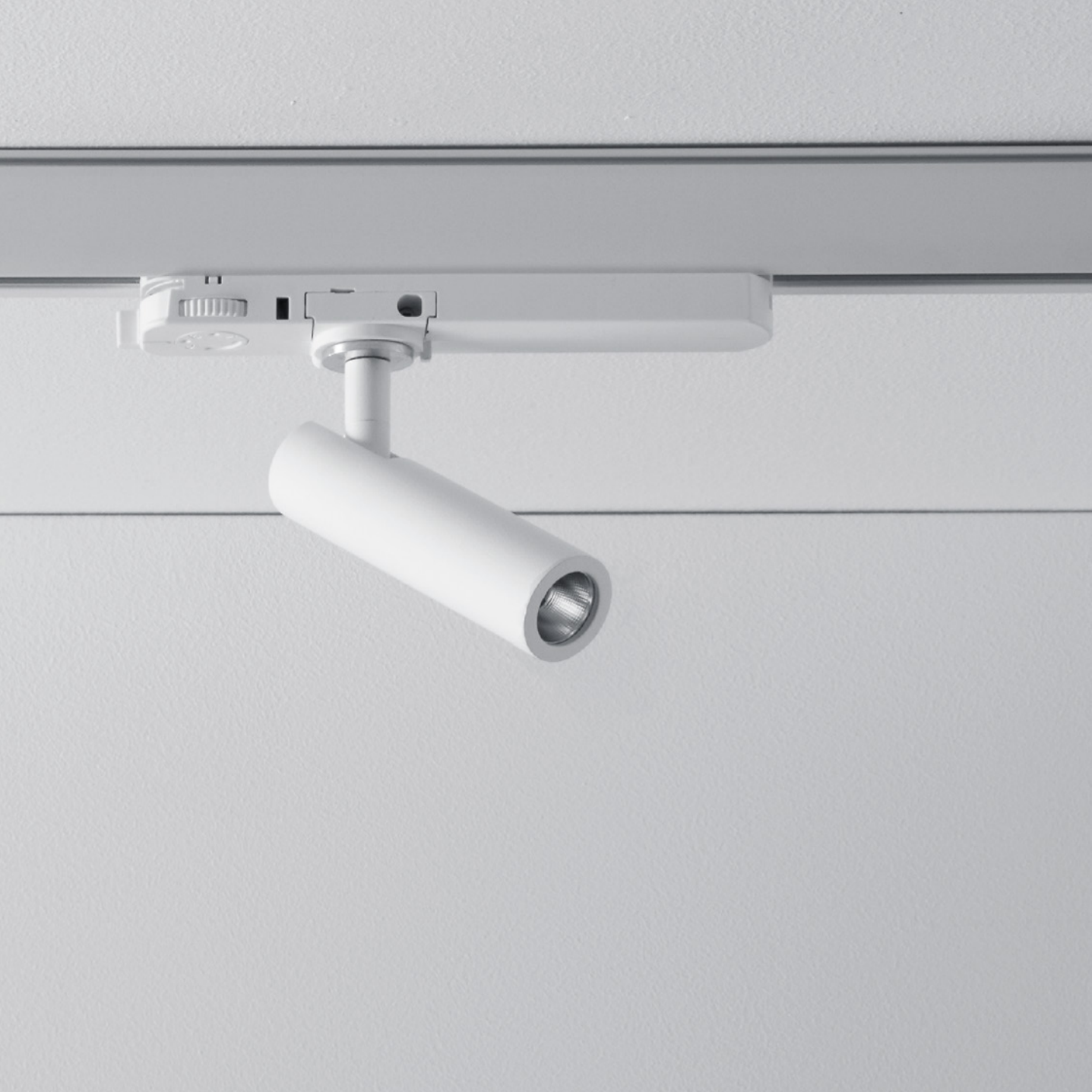

## RID KR1

The Rid KR1 luminaire is mounted to a 3-phase track and the light angle, available in 20°, 36°, 55° version, will make everyone choose the type of lamp to their needs. An advantage appreciated by even the most demanding customers is the possibility to change the direction of light, thanks to which the perception of the room changes dramatically.

Oprawa Rid KR1 montowana jest do 3-fazowego szynoprzewodu, a kąt padania światła, dostępny w wersji 20°, 36°, 55° sprawi, że każdy dobierze rodzaj lampy pod swoje upodobania. Zaletą docenianą przez nawet bardzo wymagających klientów jest możliwość zmiany kierunku padania światła, dzięki czemu diametralnie zmienia się odbiór pomieszczenia.

# RID KR1

IP 20 CE  



## Options

Opcje

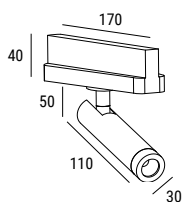

LED | 6W | 600lm |  
CRI ≥ 90 |  
weight/waga: 0,3kg |  
box/karton:  
250x150x120mm |  
mounting type  
3-phase track adapter |  
rodzaj mocowania  
szyna 3-fazowa z  
adaptorem

**K00080 . K C . L**

## 3-surface track 230V

Szynoprzewód 3-fazowy 230V

accessories p. 61

akcesoria do wyboru na str. 61

## Finishes

Wykończenia



## Optics

Optyka

K	C	L
		<b>Optics / Optyka</b>
		20 – 20°
		36 – 36°
		55 – 55°
		<b>Colour / Kolor</b>
		01 – white   biały
		02 – black   czarny
		03 – grey   szary
		04 – gold   złoty
		<b>Colour temperature / Temperatura barwowa</b>
		27 – 2700K
		30 – 3000K
		40 – 4000K



20°



36°



55°



## RID KR2

The long jib of the Rid KR2 luminaire, mounted to a 3-phase track, allows for an interesting play with light in the room. The possibility to set the tilt of the lamp independently allows you to adjust the light direction to your needs. The minimalist form will appeal to the supporters of this trend.

Długi wysięgnik oprawy Rid KR2, montowanej do szynoprzewodu 3-fazowego pozwala na ciekawą zabawę światłem w pomieszczeniu. Możliwość samodzielnego ustawiania nachylenia lampy pozwala na dostosowanie padania światła do swoich potrzeb. Minimalistyczna forma spodoba się zwolennikom tego trendu.

# RID KR2

IP 20 CE  



## Options

Opcje

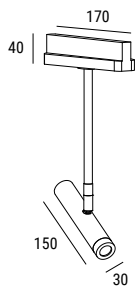

LED | 6W | 600lm |  
CRI ≥ 90 |  
weight/waga: 0,5kg |  
box/karton:  
250x250x120mm |  
mounting type  
3-phase track adapter |  
rodzaj mocowania  
szyna 3-fazowa z  
adaptorem

**K00010 . K C . L**

## 3-surface track 230V

Szynoprzewód 3-fazowy 230V

accessories p. 61

akcesoria do wyboru na str. 61

## Finishes

Wykończenia



## Optics

Optyka



20°



36°



55°

K	C	L
		<b>Optics / Optyka</b>
		20 – 20°
		36 – 36°
		55 – 55°
		<b>Colour / Kolor</b>
		01 – white   biały
		02 – black   czarny
		03 – grey   szary
		04 – gold   złoty
		<b>Colour temperature / Temperatura barwowa</b>
		27 – 2700K
		30 – 3000K
		40 – 4000K



## CUP

Cup projector distinguished by an interesting design. The aluminum body plus a reflector made of thermoplastic material ensure high visual comfort. Mounting to 48V track. Rotation of the body around its axis by 180 degrees and an angle of 90 degrees in a vertical plane, it allows for a perfect directing of the light beam to the illuminated object.

Cup projektor wyróżniający się ciekawym designem. Korpus aluminiowy plus odbłyśnik z materiału termoplastycznego zapewniają wysoki komfort wizualny. Montaż do szyny 48V. Obrót korpusu wokół własnej osi o 180st. oraz kąt 90st. w płaszczyźnie pionowej pozwala na idealne skierowanie wiązki światła na oświetlany obiekt.

# CUP

IP 20 CE  

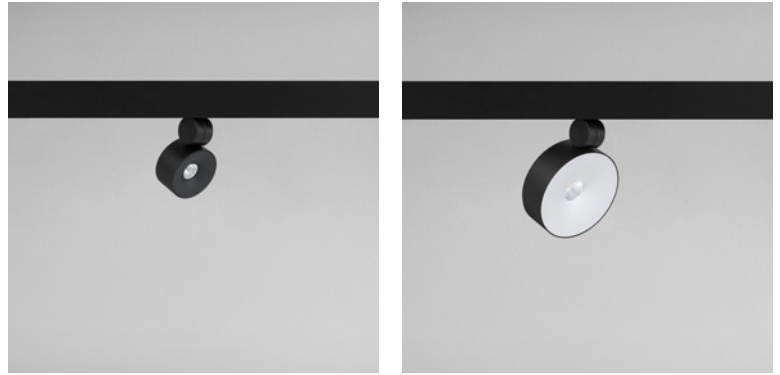

## Options

Opcje

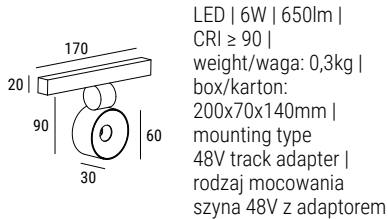

LED | 6W | 650lm |  
CRI ≥ 90 |  
weight/waga: 0,3kg |  
box/karton:  
200x70x140mm |  
mounting type  
48V track adapter |  
rodzaj mocowania  
szyna 48V z adaptorem

**P122.** E . K C . L

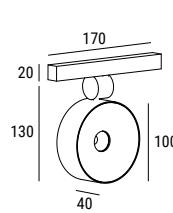

LED | 9W | 1030lm |  
CRI ≥ 90 |  
weight/waga: 0,4kg |  
box/karton:  
200x200x100mm |  
mounting type  
48V track adapter |  
rodzaj mocowania  
szyna 48V z adaptorem

**P123.** E . K C . L

## Track 48V

Szynoprzewód 48V

accessories p. 63  
akcesoria do wyboru na str. 63

## Finishes

Wykończenia

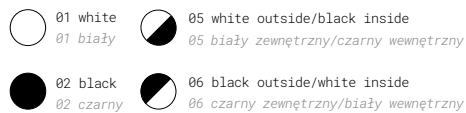

## Optics

Optyka



20°



36°



60°

E	K	C	L
			<b>Optics / Optyka</b>
			20 - 20°
			36 - 36°
			60 - 60°
			<b>Colour / Kolor</b>
			01 - white   biały
			02 - black   czarny
			05 - white / black   biały / czarny
			06 - black / white   czarny / biały
			<b>Colour temperature / Temperatura barwowa</b>
			27 - 2700K
			30 - 3000K
			40 - 4000K
			<b>Electronics / Elektronika</b>
			O - ON/OFF
			D - DALI



## CUP 100 230V

Cup projector distinguished by an interesting design. Aluminum body plus a reflector made of thermoplastic material ensures high visual comfort. Installation for 230V track. Turning of the body around its axis at 180 degrees. and angle 90st. In the vertical plane, it allows you to perfectly direct the light beam to the illuminated object.

Cup projektor wyróżniający się ciekawym designem. Korpus aluminiowy plus odbłyśnik z materiału termoplastycznego zapewniają wysoki komfort wizualny. Montaż do szyny 230V. Obrót korpusu wokół własnej osi o 180st. oraz kąt 90st. w płaszczyźnie pionowej pozwala na idealne skierowanie wiązki światła na oświetlany obiekt.



# CUP 100 230V

IP 20 CE  



## Options

Opcje

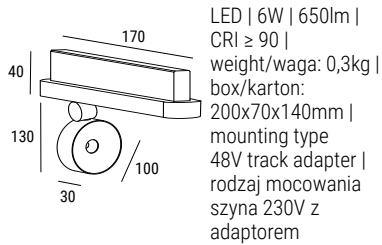

LED | 6W | 650lm |  
CRI ≥ 90 |  
weight/waga: 0,3kg |  
box/karton:  
200x70x140mm |  
mounting type  
48V track adapter |  
rodzaj mocowania  
szyna 230V z  
adaptorem

**K0010** E . K C . L

## Track 230V

Szynoprzewód 230V

accessories p. 63  
akcesoria do wyboru na str. 63

## Finishes

Wykończenia

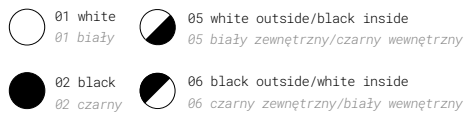

## Optics

Optyka

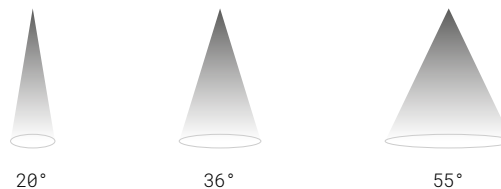

E	K	C	L
			<b>Optics / Optyka</b>
			20 - 20°
			36 - 36°
			60 - 60°
			<b>Colour / Kolor</b>
			01 - white   biały
			02 - black   czarny
			05 - white / black   biały / czarny
			06 - black / white   czarny / biały
			<b>Colour temperature / Temperatura barwowa</b>
			27 - 2700K
			30 - 3000K
			40 - 4000K
			<b>Electronics / Elektronika</b>
			O - ON/OFF
			D - DALI
			C - CASAMBI

# 3-surface track 230V

/szynoprzewód trójfazowy 230V

suspension track | szynoprzewód zwieszany  
surface mounted track | szynoprzewód nastropowy

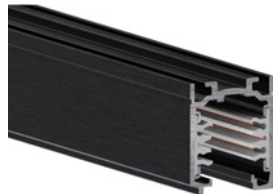
T4001.	W	C	
		01	02
		white	biały
		black	czarny
	1	1000 mm	
	2	2000 mm	
	3	3000 mm	
	4	4000 mm	

recessed track | szynoprzewód wpuszczany

T4002.	W	C	
		01	02
		white	biały
		black	czarny
	1	1000 mm	
	2	2000 mm	
	3	3000 mm	
	4	4000 mm	

suspension/surface end cap |

zaślepka do szynoprzewodu nastropowego/zwieszanego C

T414A.	C	
	01	02
	white	biały
	black	czarny

recessed end cap |

zaślepka do szynoprzewodu wpuszczanego C

T415A.	C	
	01	02
	white	biały
	black	czarny

pendant clip | uchwyt do zwieszania

T416A.	C
	00
	aluminium

steel cable | zawieszanie sufitowe

T01.	W
1	1000 mm
4	4000 mm



joining connector | łącznik elektryczny



T409A.

C

01	white	biały
02	black	czarny

insulating connection | łącznik mechaniczny



T410A.

C

01	white	biały
02	black	czarny

middle feed | zasilanie środkowe



T411A.

C

01	white	biały
02	black	czarny

X - feed | łącznik w kształcie X



T412A.

C

01	white	biały
02	black	czarny

adjustable corner | łącznik elektryczny elastyczny



T413A.

C

01	white	biały
02	black	czarny

end feed | końcówka zasilająca

earth | zasilanie



right  
left

prawe  
lewe

T401A.

T402A.

C

01	white	biały
02	black	czarny

L - feed | łącznik w kształcie L



inside  
outside

wewnętrzne  
zewewnętrzne

T403A.

T404A.

C

01	white	biały
02	black	czarny

T - feed | łącznik w kształcie T



inside left  
inside right  
outside left  
outside right

wewnętrzne lewe  
wewnętrzne prawe  
zewewnętrzne lewe  
zewewnętrzne prawe

T405A.

T406A.

T407A.

T408A.

C

01	white	biały
02	black	czarny

# Track 48V

/szynoprzewód 48V

suspension track | szynoprzewód zwieszany  
 surface mounted track | szynoprzewód nastropowy

T1001.	W	C
		01 white   biały
		02 black   czarny
1	1000 mm	
2	2000 mm	
3	3000 mm	

recessed track | szynoprzewód wpuszczany

T1002.	W	C
		01 white   biały
		02 black   czarny
1	1000 mm	
2	2000 mm	
3	3000 mm	

suspension/surface end cap |

zaślepka do szynoprzewodu nastropowego/zwieszanego C

T101A.	C
	01 white   biały
	02 black   czarny

surface and suspended end cap |

zaślepka do szynoprzewodu nastropowego i zwieszanego C

T102A.	C
	01 white   biały
	02 black   czarny

recessed dead end |

zaślepka do szynoprzewodu wpuszczanego C

T115A.	C
	01 white   biały
	02 black   czarny

aesthetic track cover 3000mm |  
 osłona do szynoprzewodu 3000mm C

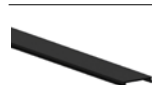
T103A.	C
	01 white   biały
	02 black   czarny

short end-feed | zasilanie krótkie C

T104A.	C
	01 white   biały
	02 black   czarny

surface mounted power supply |  
 puszka nastropowa na zasilacz C

T114A.	C
	01 white   biały
	02 black   czarny

jointing connector | łącznik krótki

C

	T105A.	01	white	biały
		02	black	czarny

mechanical jointing connector | łącznik mechaniczny

C

	T106A.	01	white	biały
		02	black	czarny

L joint | łącznik kątowy

C

	T107A.	01	white	biały
		02	black	czarny

adjustable corner | łącznik elektryczny elastyczny

C

	T108A.	01	white	biały
		02	black	czarny

recessed track mechanical corner joint | wpuszczany mechaniczny łącznik kątowy

C

	T116A.	01	white	biały
		02	black	czarny

L bracket for angles-suspension/surface track | wspornik kątowy do szynoprzewodu zwieszanego i nastropowego

T109A



suspension/surface mechanical L-joint | L-łącznik do szynoprzewodu nastropowego i zwieszanego

C

	T110A.	01	white	biały
		02	black	czarny

suspension/surface ceiling clamp | zacisk sufitowy do szynoprzewodu nastropowego i zwieszanego

C

	T111A.	01	white	biały
		02	black	czarny

pendant bracket for suspensions | uchwyt do zwieszania krótki do szynoprzewodu zwieszanego

T112A



bracket for "in row" use junction-suspension/surface track | uchwyt do zwieszania długi do szynoprzewodu nastropowego/zwieszanego

T113A



recessed track bracket for jointing connector | element do połączenia szynoprzewodu wpuszczanego

C

	T117A.	01	white	biały
		02	black	czarny

recessed track-bracket for trimless use | element łączący do szynoprzewodu wpuszczanego

T118A





**recessed / wpuszczane**



## NEAT RD

Recessed luminaire Neat will fit into any kind of interior. Designed for better comfort of the sight- which is essential in case of using the lighting for many hours – the luminaire is equipped with an anti-glare screen that helps in effective reduction of the glare to  $UGR < 19$ . You can easily align Neat with your needs due to multiplication of the luminaire.

Wpuszczana w sufit oprawa Neat wpasuje się w każdy rodzaj wnętrza. Z myślą o komforcie widzenia - co jest niezwykle ważne w przypadku wielogodzinnego korzystania z oświetlenia - wyposażono ją w przesłonę antyolśnieniową, która pozwala na skuteczne zredukowanie olśnienia do  $UGR < 19$ . Dzięki dostępności multiplikacji oprawy z łatwością dopasujesz Neat do swoich potrzeb.



# NEAT RD

IP 20 CE  

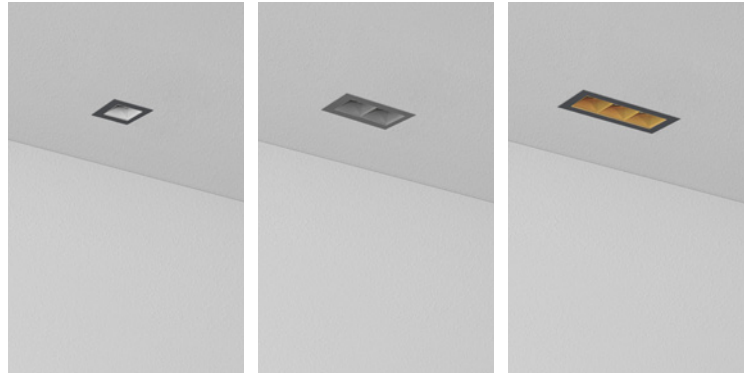

## Options

Opcje

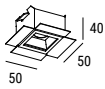

LED | 2W | 260lm |  
CRI ≥ 90 | UGR < 19 |  
weight/waga: 0,1kg |  
box/karton:  
70x70x120mm |  
⇒ 50x50mm

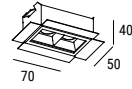

LED | 4W | 520lm |  
CRI ≥ 90 | UGR < 19 |  
weight/waga: 0,2kg |  
box/karton:  
120x100x120mm |  
⇒ 50x80mm

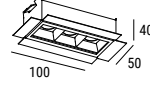

LED | 6W | 780lm |  
CRI ≥ 90 | UGR < 19 |  
weight/waga: 0,3kg |  
box/karton:  
120x100x120mm |  
⇒ 50x110mm

**R0022** E . K C . L

**R0023** E . K C . L

**R0024** E . K C . L

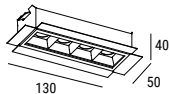

LED | 8W | 1040lm |  
CRI ≥ 90 | UGR < 19 |  
weight/waga: 0,4kg |  
box/karton:  
200x120x120mm |  
⇒ 50x140mm

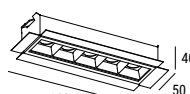

LED | 10W | 1300lm |  
CRI ≥ 90 | UGR < 19 |  
weight/waga: 0,5kg |  
box/karton:  
200x120x120mm |  
⇒ 50x170mm

**R0025** E . K C . L

**R0026** E . K C . L

E	K	C	L
			<b>Optics / Optyka</b>
			10 - 10°
			25 - 25°
			40 - 40°
			60 - 60°
			<b>Colour / Kolor</b>
			01 - white   biały
			02 - black   czarny
			03 - grey   szary
			04 - gold   złoty
			05 - white / black   biały / czarny
			06 - black / white   czarny / biały
			07 - black / gold   czarny / złoty
			08 - gold / black   złoty / czarny
			09 - grey / black   szary / czarny
			10 - black / grey   czarny / szary
			<b>Colour temperature / Temperatura barwowa</b>
			27 - 2700K
			30 - 3000K
			40 - 4000K
			<b>Electronics / Elektronika</b>
			O - ON/OFF
			D - DALI
			C - CASAMBI

## Finishes

Wykończenia



## Optics

Optyka

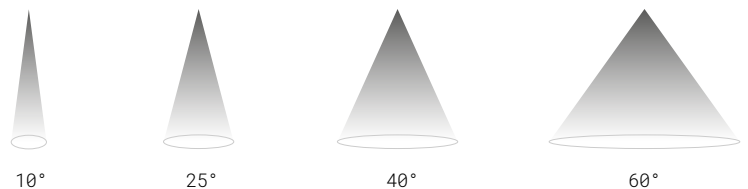



## **DROP RD1**

The Drop RD1 recessed lamp with a choice of optics for the illuminated area is a functional lighting element for a flat, house. It is a perfect idea to enlarge the space. Drop will be perfect for any type of room, and in combination with golden elements it looks extremely elegant.

Wpuszczana lampa Drop RD1 z możliwością wyboru optyki dla oświetlanej powierzchni to funkcjonalny element oświetlenia dla mieszkania, domu. Drop świetnie sprawdzi się w pomieszczeniach każdego typu, a w połączeniu ze złotymi elementami wygląda niezwykle elegancko.

# DROP RD1

IP 20 CE  



## Options

Opcje

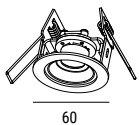

55  
LED | 2W | 260lm |  
CRI ≥ 90 |  
weight/waga: 0,1kg |  
box/karton:  
100x120x100mm |  
→ ø54mm

R00020 . K C . L

E	K	C	L
			<b>Optics / Optyka</b>
			10 – 10°
			25 – 25°
			40 – 40°
			60 – 60°
			<b>Colour / Kolor</b>
			01 – white   biały
			02 – black   czarny
			03 – grey   szary
			04 – gold   złoty
			05 – white / black   biały / czarny
			06 – black / white   czarny / biały
			07 – black / gold   czarny / złoty
			08 – gold / black   złoty / czarny
			09 – grey / black   szary / czarny
			10 – black / grey   czarny / szary
			<b>Colour temperature / Temperatura barwowa</b>
			27 – 2700K
			30 – 3000K
			40 – 4000K
			<b>Electronics / Elektronika</b>
			O – ON/OFF
			D – DALI

## Finishes

Wykończenia



## Optics

Optyka

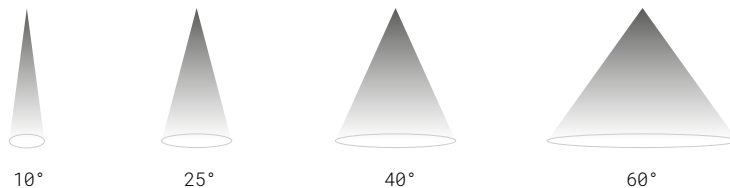



## **DROP RD4**

Drop RD4 is an innovative lamp that illuminates the room in a non-intrusive way. The light sources embedded in a simple luminaire perfectly fulfil their function. Minimalist design adapts to any interior. Stylish colours add chic and create a coherent arrangement with other elements.

Drop RD4 to innowacyjna lampa oświetlająca pomieszczenie w nienachalny sposób. Osadzone w prostej oprawie źródła światła doskonale spełniają swoją funkcję. Minimalistyczny projekt dostosowuje się do każdego wnętrza. Stylowe kolory dodają szyku oraz tworzą spójną aranżację z pozostałymi elementami.

# DROP RD4

IP 20 CE  



## Options

Opcje

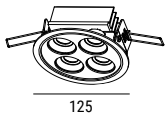

LED | 8W | 1040lm |  
CRI ≥ 90 |  
weight/waga: 0,6kg |  
box/karton:  
180x140x100mm |  
— ∅119mm

R0003 E . K C . L

E	K	C	L
			<b>Optics / Optyka</b>
			10 – 10°
			25 – 25°
			40 – 40°
			60 – 60°
			<b>Colour / Kolor</b>
			01 – white   biały
			02 – black   czarny
			03 – grey   szary
			04 – gold   złoty
			05 – white / black   biały / czarny
			06 – black / white   czarny / biały
			07 – black / gold   czarny / złoty
			08 – gold / black   złoty / czarny
			09 – grey / black   szary / czarny
			10 – black / grey   czarny / szary
			<b>Colour temperature / Temperatura barwowa</b>
			27 – 2700K
			30 – 3000K
			40 – 4000K
			<b>Electronics / Elektronika</b>
			O – ON/OFF
			D – DALI

## Finishes

Wykończenia



## Optics

Optyka

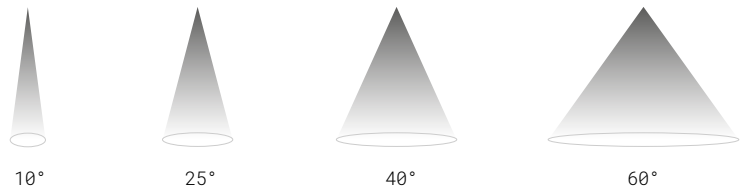



# TIVO

Tivo has a stunning, minimalist design. The classic colour scheme further enhances the versatility of this model. Tivo presents itself perfectly in the arrangement of several lamps.

Tivo charakteryzuje się zachwycającym, minimalistycznym designem. Klasyczna kolorystyka jeszcze bardziej podkreśla uniwersalność tego modelu. Tivo prezentuje się doskonale w układzie kilku lamp.

# TIVO

IP 20 CE  

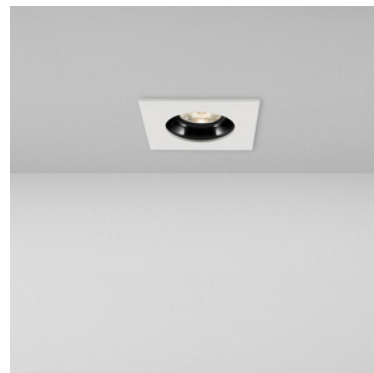

## Options

Opcje

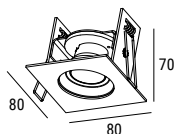

LED | 2W | 260lm |  
CRI ≥ 90 |  
weight/waga: 0,3kg |  
box/karton:  
100x120x100mm |  
→ 70x70mm

R0013 E . K C . L

E	K	C	L
			<b>Optics / Optyka</b>
			10 – 10°
			25 – 25°
			40 – 40°
			60 – 60°
			<b>Colour / Kolor</b>
			01 – white   biały
			02 – black   czarny
			03 – grey   szary
			04 – gold   złoty
			05 – white / black   biały / czarny
			06 – black / white   czarny / biały
			07 – black / gold   czarny / złoty
			08 – gold / black   złoty / czarny
			09 – grey / black   szary / czarny
			10 – black / grey   czarny / szary
			<b>Colour temperature / Temperatura barwowa</b>
			27 – 2700K
			30 – 3000K
			40 – 4000K
			<b>Electronics / Elektronika</b>
			0 – ON/OFF
			D – DALI

## Finishes

Wykończenia

 01 white 01 biały	 05 white outside/black inside 05 biały zewnętrzny/czarny wewnętrzny	 09 grey outside/black inside 09 szary zewnętrzny/czarny wewnętrzny
 02 black 02 czarny	 06 black outside/white inside 06 czarny zewnętrzny/biały wewnętrzny	 10 black outside/grey inside 10 czarny zewnętrzny/szary wewnętrzny
 03 grey 03 szary	 07 black outside/gold inside 07 czarny zewnętrzny/złoty wewnętrzny	
 04 gold 04 złoty	 08 gold outside/black inside 08 złoty zewnętrzny/czarny wewnętrzny	

## Optics

Optyka

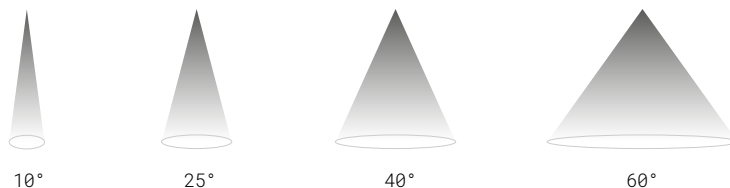



# HILO

The Hilo lamp is a functional solution that will create a unique atmosphere in a room. This model allows to achieve the effect of atmospheric play of lights and shadows in the interior. The classic shape of the circle and universal colours make Hilo suitable for any interior design.

Lampa Hilo jest funkcjonalnym rozwiązaniem, dzięki któremu w pomieszczeniu zapanuje wyjątkowa atmosfera. Model ten pozwala osiągnąć we wnętrzu efekt nastrojowej gry światła i cienia. Klasyczny kształt koła oraz uniwersalne kolory sprawiają, że Hilo sprawdzi się w każdej aranżacji danego wnętrza.



# HILO

IP 20 CE  



## Options

Opcje

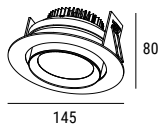

LED | 8W | 900lm |  
CRI ≥ 90 |  
weight/waga: 0,8kg |  
box/karton:  
190x190x140mm |  
⇨ ø130mm

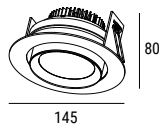

LED | 14W | 1600lm |  
CRI ≥ 90 |  
weight/waga: 0,8kg |  
box/karton:  
190x190x140mm |  
⇨ ø130mm

R0020 E . K C . L

R0021 E . K C . L

E	K	C	L
<b>Optics / Optyka</b>			
36 – 36°			
60 – 60°			
<b>Colour / Kolor</b>			
01 – white   biały			
02 – black   czarny			
03 – grey   szary			
04 – gold   złoty			
<b>Colour temperature / Temperatura barwowa</b>			
27 – 2700K			
30 – 3000K			
40 – 4000K			
<b>Electronics / Elektronika</b>			
O – ON/OFF			
D – DALI			
C – CASAMBI			

## Finishes

Wykończenia



## Optics

Optyka



36°



60°



## PIKS

The Píks is a lighting proposal that captivates with its simplicity. The use of a circle motif is perfect for ceiling lamp designs. Timeless colours emphasize modernity as well as classics in the interior. The Píks not only illuminates the room properly, but also fits into the adopted style.

Píks to propozycja oświetlenia, która urzeka swoją prostotą. Wykorzystanie motywu koła doskonale sprawdza się w projektach lamp sufitowych. Ponadczasowe kolory podkreślają nowoczesność, jak i klasykę we wnętrzu. Píks nie tylko odpowiednio oświetla pomieszczenie, ale też wpasowuje się w przyjęty styl.

# PIKS

IP20 CE  

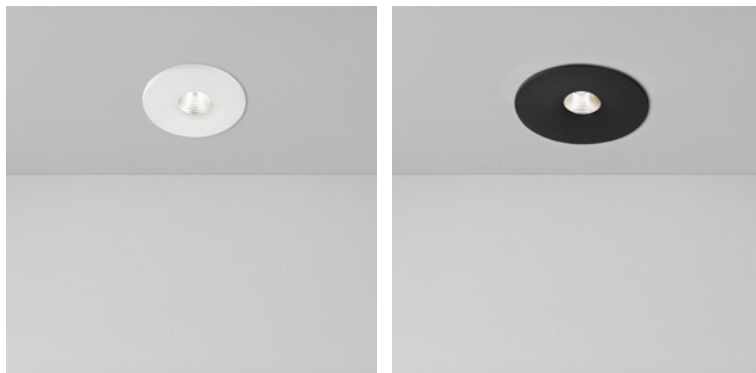

## Options

Opcje

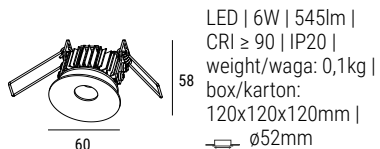

LED | 6W | 545lm |  
CRI ≥ 90 | IP20 |  
weight/waga: 0,1kg |  
box/karton:  
120x120x120mm |  
— ø52mm

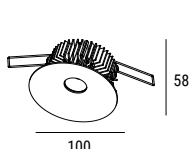

LED | 10W | 900lm |  
CRI ≥ 90 | IP20 |  
weight/waga: 0,2kg |  
box/karton:  
150x120x120mm |  
— ø80mm

**R0035** E . K C . L

**R0036** E . K C . L

## Finishes

Wykończenia

-  01 white  
01 biały
-  02 black  
02 czarny

## Optics

Optyka



20°



36°



60°

E	K	C	L
<b>Optics / Optyka</b>			
20 - 20°			
36 - 36°			
60 - 60°			
<b>Colour / Kolor</b>			
01 - white   biały			
02 - black   czarny			
<b>Colour temperature / Temperatura barwowa</b>			
27 - 2700K			
30 - 3000K			
40 - 4000K			
<b>Electronics / Elektronika</b>			
O - ON/OFF			
D - DALI			



## PIKS IP44

The Píks is a lighting proposal that captivates with its simplicity. The use of a circle motif is perfect for ceiling lamp designs. Timeless colours emphasize modernity as well as classics in the interior. The Píks not only illuminates the room properly, but also fits into the adopted style.

Píks to propozycja oświetlenia, która urzeka swoją prostotą. Wykorzystanie motywu koła doskonale sprawdza się w projektach lamp sufitowych. Ponadczasowe kolory podkreślają nowoczesność, jak i klasykę we wnętrzu. Píks nie tylko odpowiednio oświetla pomieszczenie, ale też wpasowuje się w przyjęty styl.

# PIKS IP44

IP44 CE  



## Options

Opcje

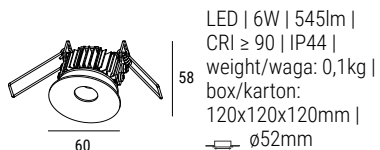

LED | 6W | 545lm |  
CRI ≥ 90 | IP44 |  
weight/waga: 0,1kg |  
box/karton:  
120x120x120mm |  
— ø52mm

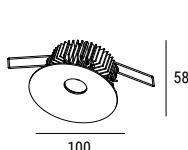

LED | 10W | 900lm |  
CRI ≥ 90 | IP44 |  
weight/waga: 0,2kg |  
box/karton:  
150x120x120mm |  
— ø80mm

**R0047** E . K C . L

**R0048** E . K C . L

## Finishes

Wykończenia

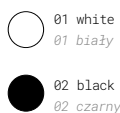

## Optics

Optyka



20°



36°



60°

**E** **K** **C** **L**

### Optics / Optyka

20 – 20°

36 – 36°

60 – 60°

### Colour / Kolor

01 – white | biały

02 – black | czarny

### Colour temperature / Temperatura barwowa

27 – 2700K

30 – 3000K

40 – 4000K

### Electronics / Elektronika

O – ON/OFF

D – DALI



## SPEAKER RD60

The Speaker RD60 luminaire is a unique model, whose greatest advantage is its originality. Its unique appearance inspired by loud-speakers does not overwhelm the interior, but becomes an interesting element of the decor. The lamp emits atmospheric light and creates a unique atmosphere. It is a great choice for fans of modernity.

Oprawa Speaker RD60 to unikatowy model, którego największą zaletą jest oryginalność. Jego nietuzinkowy wygląd inspirowany głośnikami nie przytłacza wnętrza, za to staje się ciekawym elementem wystroju. Lampa daje klimatyczne światło i tworzy wyjątkowy nastrój. To świetny wybór dla fanów nowoczesności.

# SPEAKER RD60

IP20 CE  



## Options

Opcje

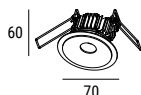

LED | 6W | 545lm |  
CRI ≥ 90 | IP20 |  
weight/waga: 0,3kg |  
box/karton:  
120x120x120mm |  
— ∅62mm

**R0037** E . K C . L

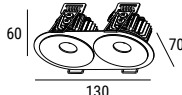

LED | 11W | 1090lm |  
CRI ≥ 90 | IP20 |  
weight/waga: 0,5kg |  
box/karton:  
180x140x100mm |  
— 122x62mm

**R0038** E . K C . L

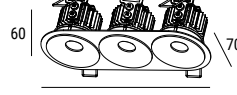

LED | 16W | 1640lm |  
CRI ≥ 90 | IP20 |  
weight/waga: 0,6kg |  
box/karton:  
240x120x100mm |  
— 182x62mm

**R0039** E . K C . L

## Finishes

Wykończenia

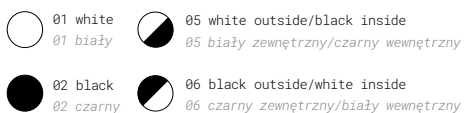

## Optics

Optyka



20°



36°



60°

**E** **K** **C** **L**

Optics / Optyka

20 – 20°

36 – 36°

60 – 60°

Colour / Kolor

01 – white | biały

02 – black | czarny

05 – white / black | biały / czarny

06 – black / white | czarny / biały

Colour temperature / Temperatura barwowa

27 – 2700K

30 – 3000K

40 – 4000K

Electronics / Elektronika

O – ON/OFF

D – DALI



## **SPEAKER RD60 IP44**

The Speaker RD60 luminaire is a unique model, whose greatest advantage is its originality. Its unique appearance inspired by loud-speakers does not overwhelm the interior, but becomes an interesting element of the decor. The lamp emits atmospheric light and creates a unique atmosphere. It is a great choice for fans of modernity.

Oprawa Speaker RD60 to unikatowy model, którego największą zaletą jest oryginalność. Jego nietuzinkowy wygląd inspirowany głośnikami nie przytłacza wnętrza, za to staje się ciekawym elementem wystroju. Lampa daje klimatyczne światło i tworzy wyjątkowy nastrój, To świetny wybór dla fanów nowoczesności.



# SPEAKER RD60

## IP44

IP44 CE  



### Options

Opcje



LED | 6W | 545lm |  
CRI ≥ 90 |  
weight/waga: 0,3kg |  
box/karton:  
120x120x120mm |  
→ ø62mm

**R00331** E . K C . L

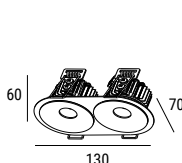

LED | 11W | 1090lm |  
CRI ≥ 90 |  
weight/waga: 0,5kg |  
box/karton:  
180x140x100mm |  
→ 122x62mm

**R00332** E . K C . L

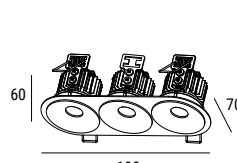

LED | 16W | 1640lm |  
CRI ≥ 90 |  
weight/waga: 0,6kg |  
box/karton:  
240x120x100mm |  
→ 182x62mm

**R00333** E . K C . L

**E K C L**

#### Optics / Optyka

20 - 20°  
36 - 36°  
60 - 60°

#### Colour / Kolor

01 - white | biały  
02 - black | czarny  
05 - white / black | biały / czarny  
06 - black / white | czarny / biały

#### Colour temperature / Temperatura barwowa

27 - 2700K  
30 - 3000K  
40 - 4000K

#### Electronics / Elektronika

O - ON/OFF  
D - DALI

### Finishes

Wykończenia



01 white  
01 biały



05 white outside/black inside  
05 biały zewnętrzny/czarny wewnętrzny



02 black  
02 czarny



06 black outside/white inside  
06 czarny zewnętrzny/biały wewnętrzny

### Optics

Optyka



20°



36°



60°



## **SPEAKER RD100**

The Speaker RD100 luminaire will satisfy all those who are looking for unusual, modern solutions. The colour contrast further enhances the original shape of the lamp. It is the form inspired by speakers that distinguishes Speaker from other models. The lamp also impresses with its functionality.

Oprawa Speaker RD100 zadowoli wszystkich tych, którzy poszukują nietuzinkowych, nowoczesnych rozwiązań. Kontrast kolorystyczny jeszcze bardziej podkreśla oryginalny kształt lampy. To właśnie forma inspirowana głośnikami wyróżnia Speaker spośród innych modeli. Lampa zachwyca także swoją funkcjonalnością.

# SPEAKER RD100

IP 20 CE  



## Options

Opcje

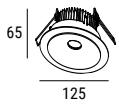

LED | 10W | 900lm |  
CRI ≥ 90 |  
weight/waga: 0,5kg |  
box/karton:  
180x140x100mm |  
— ø105mm

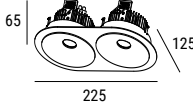

LED | 19W | 1810lm |  
CRI ≥ 90 |  
weight/waga: 0,6kg |  
box/karton:  
330x190x140mm |  
— 210x105mm

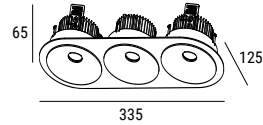

LED | 28W | 2710lm |  
CRI ≥ 90 |  
weight/waga: 0,8kg |  
box/karton:  
400x120x100mm |  
— 315x105mm

**R0040** E . K C . L

**R0041** E . K C . L

**R0042** E . K C . L

## Finishes

Wykończenia

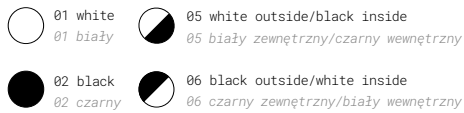

## Optics

Optyka



20°



36°



60°

**E** **K** **C** **L**

Optics / Optyka

20 - 20°

36 - 36°

60 - 60°

Colour / Kolor

01 - white | biały

02 - black | czarny

05 - white / black | biały / czarny

06 - black / white | czarny / biały

Colour temperature / Temperatura barwowa

27 - 2700K

30 - 3000K

40 - 4000K

Electronics / Elektronika

O - ON/OFF

P - DALI



## **SPEAKER RD100 IP44**

The Speaker RD100 luminaire will satisfy all those who are looking for unusual, modern solutions. The colour contrast further enhances the original shape of the lamp. It is the form inspired by speakers that distinguishes Speaker from other models. The lamp also impresses with its functionality.

Oprawa Speaker RD100 zadowolili wszystkich tych, którzy poszukują nietuzinkowych, nowoczesnych rozwiązań. Kontrast kolorystyczny jeszcze bardziej podkreśla oryginalny kształt lampy. To właśnie forma inspirowana głośnikami wyróżnia Speaker spośród innych modeli. Lampa zachwyca także swoją funkcjonalnością.

# SPEAKER RD100

## IP44

IP44 CE  

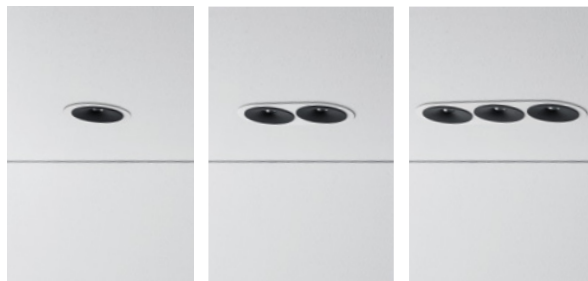

### Options

Opcje

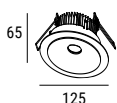

LED | 10W | 900lm |  
CRI ≥ 90 |  
weight/waga: 0,5kg |  
box/karton:  
180x140x100mm |  
— ø105mm

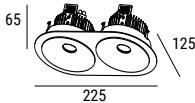

LED | 19W | 1810lm |  
CRI ≥ 90 |  
weight/waga: 0,6kg |  
box/karton:  
330x190x140mm |  
— 210x105mm

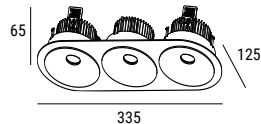

LED | 28W | 2710lm |  
CRI ≥ 90 |  
weight/waga: 0,8kg |  
box/karton:  
400x120x100mm |  
— 315x105mm

**R00341** E . K C . L

**R00342** E . K C . L

**R00343** E . K C . L

**E** **K** **C** **L**

#### Optics / Optyka

20 – 20°  
36 – 36°  
60 – 60°

#### Colour / Kolor

01 – white | biały  
02 – black | czarny  
05 – white / black | biały / czarny  
06 – black / white | czarny / biały

#### Colour temperature / Temperatura barwowa

27 – 2700K  
30 – 3000K  
40 – 4000K

#### Electronics / Elektronika

O – ON/OFF  
D – DALI

### Finishes

Wykończenia



01 white  
01 biały



05 white outside/black inside  
05 biały zewnętrzny/czarny wewnętrzny



02 black  
02 czarny



06 black outside/white inside  
06 czarny zewnętrzny/biały wewnętrzny

### Optics

Optyka



20°



36°



60°

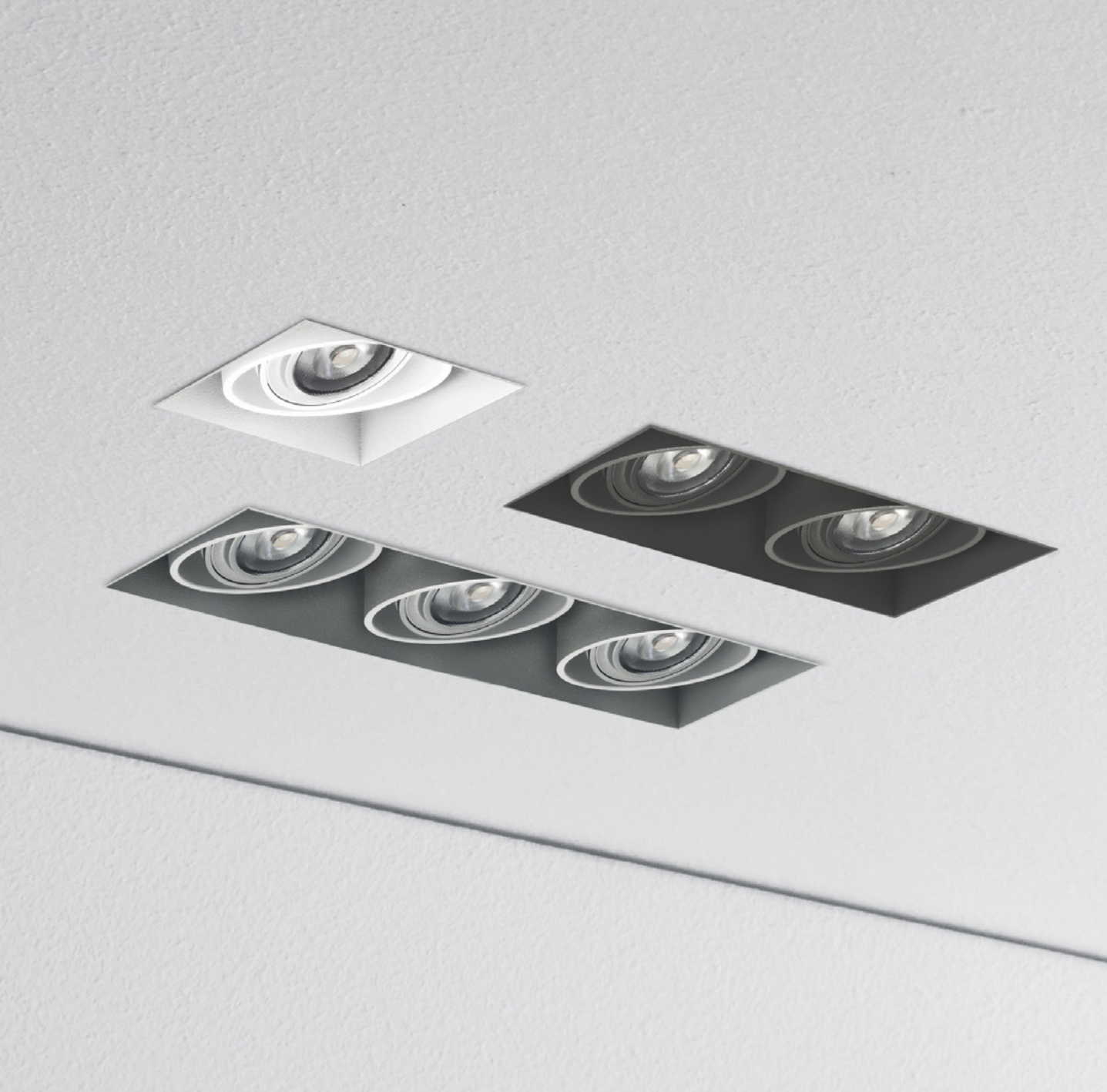

## ERO RD1

Recessed Ero luminaire without a frame perfectly fits the surface of the ceiling. The simple and minimalistic form makes the luminaire inconspicuous and perfectly fits in modern esthetics.

Wpuszczana w sufit oprawa Ero bez ramki idealnie łączy się z powierzchnią sufitu. Prosta i minimalistyczna forma sprawia, że oprawa nie rzuca się w oczy oraz doskonale pasuje do nowoczesnej stylistyki.

# ERO RD1

IP 20 CE  

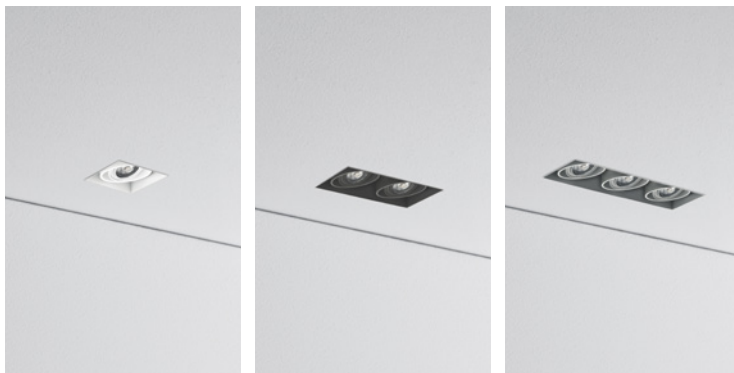

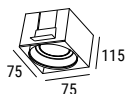

## Options

Opcje

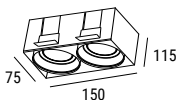

GU10 | max 50W   
weight/waga: 0,8kg |  
box/karton:  
120x120x120mm |  
⇨ 80x80mm



GU10 | max 50W   
weight/waga: 1,2kg |  
box/karton:  
200x120x120mm |  
⇨ 155x80mm

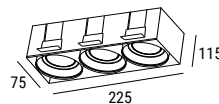

GU10 | max 50W   
weight/waga: 1,7kg |  
box/karton:  
250x120x120mm |  
⇨ 230x80mm

R00270 . 0 C . 0

R00280 . 0 C . 0

R00290 . 0 C . 0

## Finishes

Wykończenia

**C**

Colour / Kolor

01 - white | biały

02 - black | czarny

03 - grey | szary

04 - gold | złoty



01 white  
01 biały



03 grey  
03 szary



02 black  
02 czarny



04 gold  
04 złoty

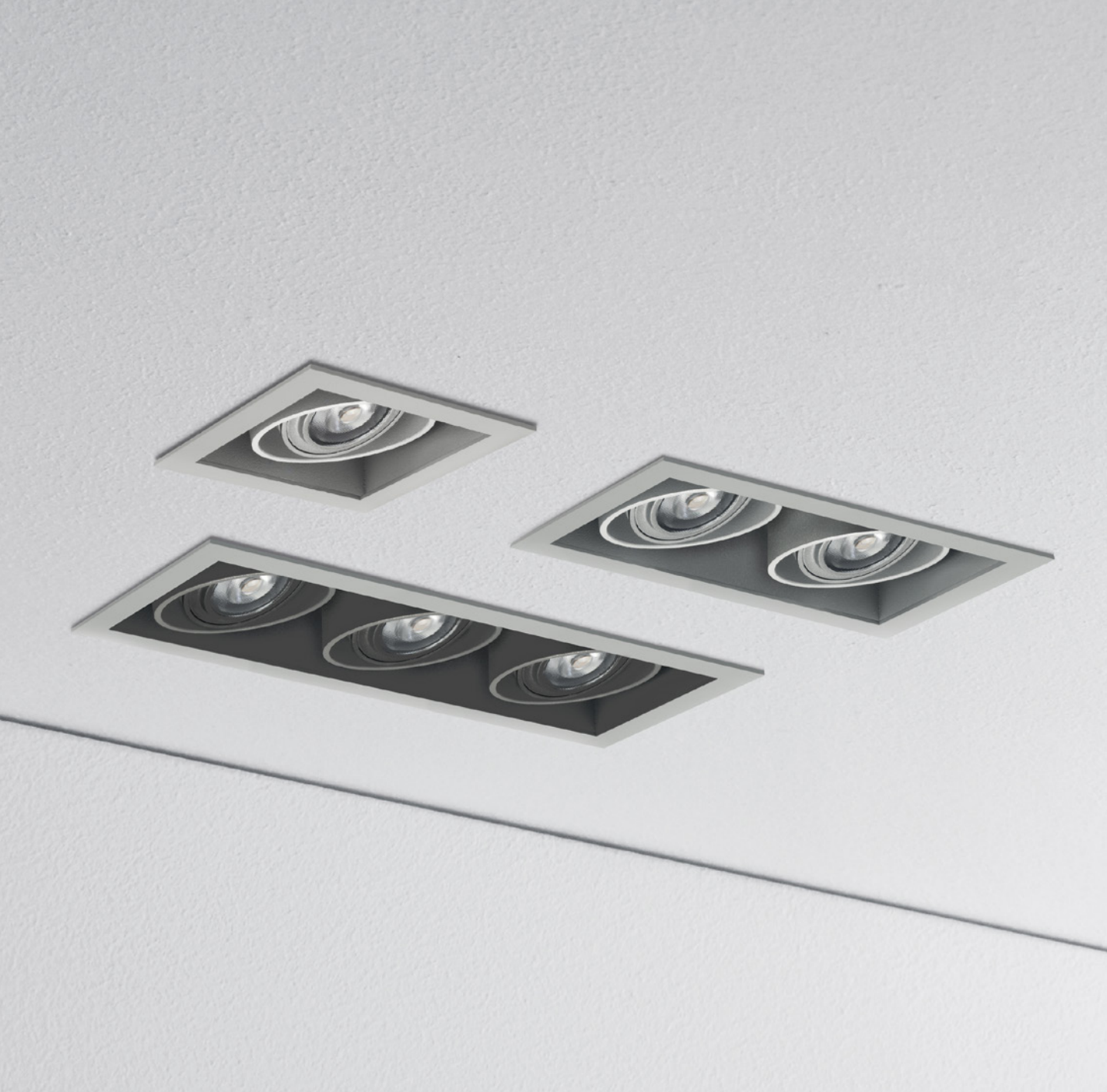

## ERO RD2

What characterizes the recessed Ero luminaire is the possibility of a fast and simple change in the position of the light beam. The luminaire is made of high-quality steel with a replaceable light source with GU10 fitting. Thanks to the multiplication of the luminaire which helps you adjust Ero to your needs.

Wpuszczaną w sufit oprawę Ero cechuje możliwość szybkiej i prostej zmiany położenia kierunku strumienia światła. Oprawa wykonana jest z wysokiej jakości stali z wymiennym źródłem na trzonek GU10. Dzięki multiplikacji oprawy dostosujesz ją do swoich wymagań.



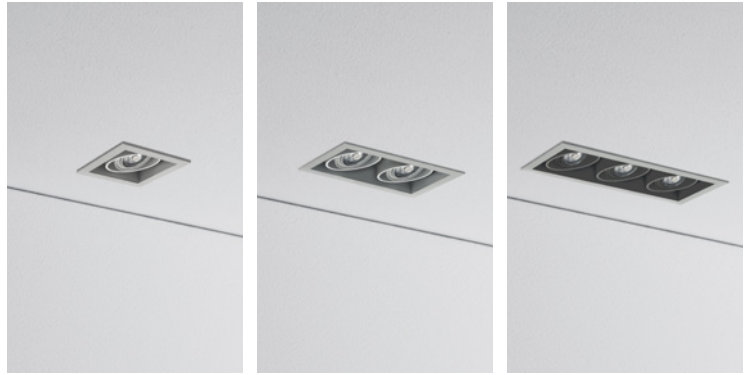

# ERO RD2

IP 20 CE  

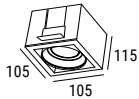

## Options Opcje



GU10 | max 50W   
weight/waga: 1kg |  
box/karton: 120x120x120mm |  
→ 80x80mm

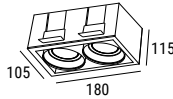

GU10 | max 50W   
weight/waga: 1,7kg |  
box/karton: 200x120x120mm |  
→ 155x80mm

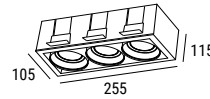

GU10 | max 50W   
weight/waga: 2,4kg |  
box/karton: 280x120x120mm |  
→ 230x80mm

R00300 . 0 C . 0

R00310 . 0 C . 0

R00320 . 0 C . 0

C
Colour / Kolor
01 - white   biały
02 - black   czarny
03 - grey   szary
04 - gold   złoty
05 - white / black   biały / czarny
06 - black / white   czarny / biały
07 - black / gold   czarny / złoty
08 - gold / black   złoty / czarny
09 - grey / black   szary / czarny
10 - black / grey   czarny / szary

## Finishes Wykończenia

 01 white 01 biały	 05 white outside/black inside 05 biały zewnętrzny/czarny wewnętrzny	 09 grey outside/black inside 09 szary zewnętrzny/czarny wewnętrzny
 02 black 02 czarny	 06 black outside/white inside 06 czarny zewnętrzny/biały wewnętrzny	 10 black outside/grey inside 10 czarny zewnętrzny/szary wewnętrzny
 03 grey 03 szary	 07 black outside/gold inside 07 czarny zewnętrzny/złoty wewnętrzny	
 04 gold 04 złoty	 08 gold outside/black inside 08 złoty zewnętrzny/czarny wewnętrzny	



## RID RD1

The Rid RD1 lamp is a practical model, which is characterized by an uncomplicated but impressive design. Thanks to its simple form and subdued colours it delights the supporters of minimalism. This model will find its place in modern arrangements. The light of Rid lamp will be an unquestionable value of the interior.

Lampa Rid RD1 to praktyczny model, który cechuje się nieskomplikowaną, ale efektowną konstrukcją. Dzięki prostej formie oraz stonowanym kolorom zachwyca zwolenników minimalizmu. Model ten doskonale odnajdzie się w nowoczesnych aranżacjach. Światło lampy Rid będzie niekwestionowanym walorem wnętrza.

# RID RD1

IP 20 CE  



## Options

Opcje

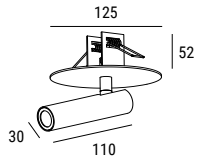

LED | 6W | 600lm |  
 CRi ≥ 90 |  
 weight/waga: 0,5kg |  
 box/karton:  
 250x150x120mm |  
 ø40mm

R0049 E . K C . L

E	K	C	L
			<b>Optics / Optyka</b>
			20 – 20°
			36 – 36°
			55 – 55°
			<b>Colour / Kolor</b>
			01 – white   biały
			02 – black   czarny
			03 – grey   szary
			04 – gold   złoty
			<b>Colour temperature / Temperatura barwowa</b>
			27 – 2700K
			30 – 3000K
			40 – 4000K
			<b>Electronics / Elektronika</b>
			O – ON/OFF
			D – DALI
			C – CASAMBI

## Finishes

Wykończenia



## Optics

Optyka



20°



36°



55°



## **HOLD RD1**

Hold RD1 is a proposal for lighting modern, stylish interiors. The lamp attached to the ceiling becomes a decoration that catches the eye and enriches the room decor. This luminaire climatically brightens the interior, creating an interesting visual effect. The high quality of the lamp meets the highest requirements.

Hold RD1 to propozycja oświetlenia nowoczesnych, stylowych wnętrz. Przymocowana do sufitu lampa staje się dekoracją, która przykuwa wzrok i wzbogaca wystrój pomieszczenia. Ta oprawa klimatycznie rozjaśnia wnętrze, tworząc ciekawy efekt wizualny. Wysoka jakość wykonania lampy spełnia najwyższe wymagania .

# HOLD RD1

IP 20 CE  



## Options

Opcje

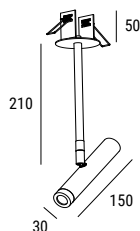

LED | 6W | 600lm |  
 CRI ≥ 90 |  
 weight/waga: 0,5kg |  
 box/karton:  
 330x190x140mm |  
 → ø70mm

R0005 E . K C . L

## Finishes

Wykończenia



## Optics

Optyka



20°



36°

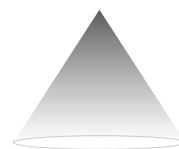

55°

E	K	C	L
			<b>Optics / Optyka</b>
			20 – 20°
			36 – 36°
			55 – 55°
			<b>Colour / Kolor</b>
			01 – white   biały
			02 – black   czarny
			03 – grey   szary
			04 – gold   złoty
			<b>Colour temperature / Temperatura barwowa</b>
			27 – 2700K
			30 – 3000K
			40 – 4000K
			<b>Electronics / Elektronika</b>
			O – ON/OFF
			D – DALI
			C – CASAMBI



## NOK RD2

The Nok RD2 lamp was made with attention to every detail. Its simple, classic form works well in rooms where minimalism reigns. It is impressive not only in its appearance, but also in its atmospheric light. The lamp available in universal colours is a perfect complement to a stylish interior.

Lampa Nok RD2 została wykonana z dbałością o każdy szczegół. Jej prosta, klasyczna forma świetnie sprawdza się w pomieszczeniach, w których króluje minimalizm. Zachwyca nie tylko wyglądem, ale też nastrojowym światłem. Lampa dostępna w uniwersalnych kolorach to doskonałe dopełnienie stylowego wnętrza.

# NOK RD2

IP 20 CE  



## Options

Opcje

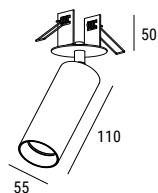

LED | 6W | 530lm |  
CRI ≥ 90 |  
weight/waga: 0,4kg |  
box/karton:  
85x95x200mm |  
— ø50mm

R0043 E . K C . 36

**E K C**

### Colour / Kolor

01 - white | biały

02 - black | czarny

03 - grey | szary

04 - gold | złoty

### Colour temperature / Temperatura barwowa

27 - 2700K

30 - 3000K

40 - 4000K

### Electronics / Elektronika

O - ON/OFF

D - DALI

C - CASAMBI

## Finishes

Wykończenia



01 white  
01 biały



03 grey  
03 szary



02 black  
02 czarny



04 gold  
04 złoty

## Optics

Optyka



36°



## NOK RD1

Nok RD1 is a unique ceiling lamp that fits into current interior design trends. All its elements form a coherent, thoughtful whole. Even when switched off, it looks aesthetically and stylishly. It allows to achieve incredible visual effects in a room thanks to the play of light and shadow.

Nok RD1 to wyjątkowa lampa sufitowa, która wpisuje się w obecne trendy wnętrzarskie. Wszystkie jej elementy stanowią spójną, przemyślaną całość. Nawet wyłączona prezentuje się estetycznie oraz stylowo. Pozwala osiągnąć w pomieszczeniu niesamowite efekty wizualne dzięki grze światła i cienia.



# NOK RD1

IP 20 CE  



## Options

Opcje

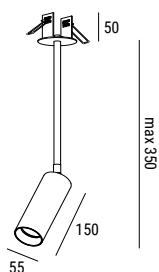

LED | 6W | 530lm |  
CRI ≥ 90 |  
weight/waga: 0,5kg |  
box/karton:  
85x95x400mm |  
— ø50mm

R0044 E . K C . 36

**E** **K** **C**

### Colour / Kolor

01 - white | biały

02 - black | czarny

03 - grey | szary

04 - gold | złoty

### Colour temperature / Temperatura barwowa

27 - 2700K

30 - 3000K

40 - 4000K

### Electronics / Elektronika

O - ON/OFF

D - DALI

C - CASAMBI

## Finishes

Wykończenia



01 white  
01 biały



03 grey  
03 szary



02 black  
02 czarny



04 gold  
04 złoty

## Optics

Optyka



36°



## HED RD1

The Hed RD1 luminaire will be a suitable solution for those who arrange their interiors in a minimalist style. Its simple and at the same time interesting shape will undoubtedly intrigue and interest you. It will look great on its own and in combination with other lamps. It is available in four colours.

Oprawa Hed RD1 będzie odpowiednim rozwiązaniem dla osób urządzających swoje wnętrza w stylu minimalistycznym. Jej prosty, a zarazem ciekawy kształt bez wątpienia zaintryguje i zaciekaWi. Doskonale będzie prezentować się w pojedynkę, jak i w połączeniu z innymi lampami. Jest dostępna w czterech kolorach.

# HED RD1



IP20 CE  

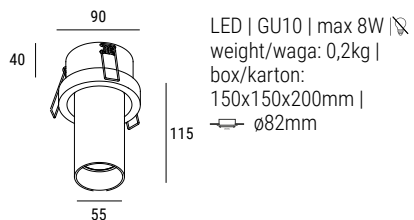

## Options

Opcje



LED | GU10 | max 8W |   
weight/waga: 0,2kg |  
box/karton:  
150x150x200mm |  
  $\varnothing$ 82mm

R00180 . 0 C . 0

## Finishes

Wykończenia

**C**

Colour / Kolor

01 - white | biały

02 - black | czarny

03 - grey | szary

04 - gold | złoty



01 white  
01 biały



03 grey  
03 szary



02 black  
02 czarny



04 gold  
04 złoty



## HED RD2

The Hed RD2 lamp will certainly impress with its original shape. Its great advantage is the possibility to set it at a chosen angle. An additional phase dimming function will make the lighting gain an interesting atmosphere. So it will be fantastic in the bedroom or living room. The lamp is available in four finishes.

Lampa Hed RD2 z pewnością zachwyci niebanalnym kształtem. Jej dużym atutem jest możliwość ustawienia jej pod wybranym kątem. Dodatkowa funkcja ściemniania fazowego sprawi, że oświetlenie nabierze ciekawego klimatu. Fantastycznie sprawdzi się więc w sypialni czy salonie. Lampa dostępna jest w czterech wykończeniach.

# HED RD2

IP 20 CE  

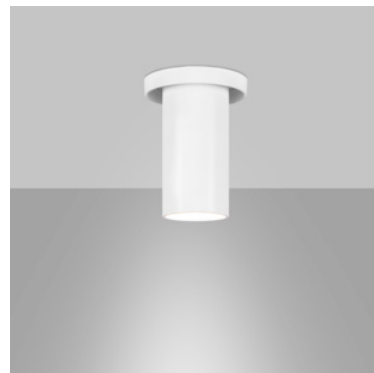

## Options

Opcje

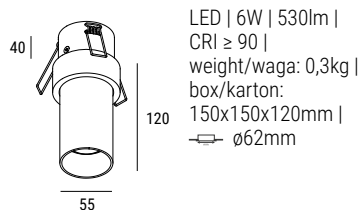

R0045 E . K C . 36

E K C

### Colour / Kolor

01 - white | biały

02 - black | czarny

03 - grey | szary

04 - gold | złoty

### Colour temperature / Temperatura barwowa

27 - 2700K

30 - 3000K

40 - 4000K

### Electronics / Elektronika

O - ON/OFF

D - DALI

C - CASAMBI

## Finishes

Wykończenia



## Optics

Optyka



36°



# MILS

Mils undoubtedly intrigues with its shape. It will be an ideal solution in modern rooms. Its unique construction makes it easy to light up even the darkest corners. Anti-glare ring is available in different colour variants.

Mils bez wątplenia intryguje swoim kształtem. Będzie idealnym rozwiązaniem w pomieszczeniach nowoczesnych. Jej nietuzinkowa budowa sprawia, że bez problemu doświetli nawet najciemniejsze zakamarki. Pierścień antyolśnieniowy jest dostępny w różnych wariantach kolorystycznych.

# MILS

IP 20 CE  

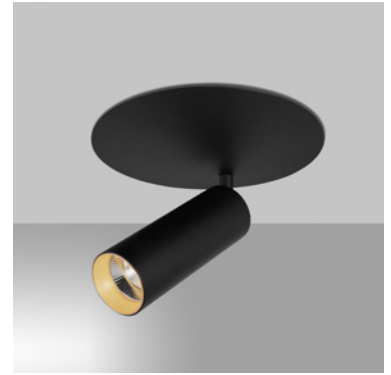

## Options

Opcje

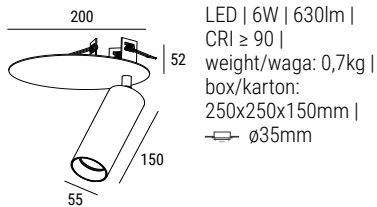

LED | 6W | 630lm |  
CRI ≥ 90 |  
weight/waga: 0,7kg |  
box/karton:  
250x250x150mm |  
— ø35mm

R0046 E . K C . L

E	K	C	L
<b>Optics / Optyka</b>			
36 - 36°			
60 - 60°			
<b>Colour / Kolor</b>			
02 - black   czarny			
06 - black / white   czarny / biały			
07 - black / gold   czarny / złoty			
10 - black / grey   czarny / szary			
<b>Colour temperature / Temperatura barwowa</b>			
27 - 2700K			
30 - 3000K			
40 - 4000K			
<b>Electronics / Elektronika</b>			
O - ON/OFF			
D - DALI			
C - CASAMBI			

## Finishes

Wykończenia

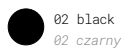

02 black  
02 czarny



07 black outside/gold inside  
07 czarny zewnętrzny/złoty wewnętrzny



06 black outside/white inside  
06 czarny zewnętrzny/biały wewnętrzny



10 black outside/grey inside  
10 czarny zewnętrzny/szary wewnętrzny

## Optics

Optyka



36°



60°





**surface / nastropowe**



# BROOKLYN OP

The design of the Brooklyn luminaire was based on a combination of two elements: minimalism in the form while maintaining its maximum efficiency. Properly designed optics in the Brooklyn luminaire focuses on providing the highest possible comfort in a given room. Brooklyn has a simple shape and at the same time high luminous efficiency. It was designed for private interiors but it will also work well in other spaces.

Projekt oprawy Brooklyn opierał się na połączeniu dwóch elementów: minimalizmu w formie z zachowaniem maksymalnej jej wydajności. Odpowiednio zaprojektowana optyka w oprawie Brooklyn skupia się na zapewnieniu jak najwyższego komfortu przebywania w danym pomieszczeniu. Brooklyn ma prosty kształt a jednocześnie dużą skuteczność świetlną. Została zaprojektowana z myślą o wnętrzach prywatnych ale sprawdzi się również w innych przestrzeniach.

# BROOKLYN OP

IP 20 CE  

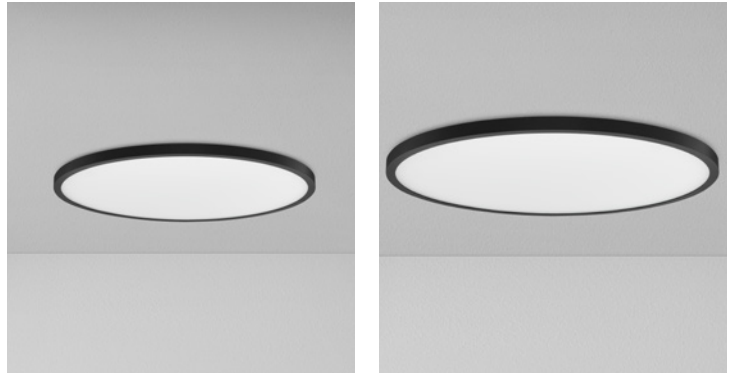

## Options

Opcje

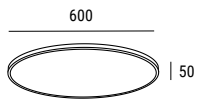

LED | 43W | 3860lm |  
CRI ≥ 90 |  
weight/waga: 8,7kg |  
box/karton:  
620x620x70mm |

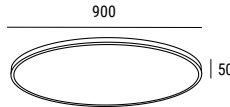

LED | 62W | 5110lm |  
CRI ≥ 90 |  
weight/waga: 13,8kg |  
box/karton:  
920x920x70mm |

M0030 E . K C . 0

M0031 E . K C . 0

## Finishes

Wykończenia

E K C

Colour / Kolor

01 - white | biały

02 - black | czarny

03 - grey | szary

04 - gold | złoty

Colour temperature / Temperatura barwowa

27 - 2700K

30 - 3000K

40 - 4000K

Electronics / Elektronika

O - ON/OFF

D - DALI

C - CASAMBI





# ATRO

The modern, geometric Atró luminaire with an uncomplicated structure is a combination of efficiency and simplicity. The light coming from the luminaire is ideally scattered over the entire surface of the diffuser. It is an ideal solution in spaces where we need general lighting. The luminaire is available in two sizes.

Nowoczesna, geometryczna oprawa Atró o nieskomplikowanej budowie, jest połączeniem efektywności z prostotą. Światło wychodzące z oprawy rozproszone jest idealnie po całej powierzchni dyfuzora. To idealne rozwiązanie w przestrzeniach, gdzie potrzebujemy ogólnego oświetlenia. Oprawa dostępna jest w dwóch wymiarach.

# ATRO

IP 20 CE  



## Options

### Opcje

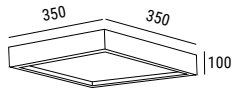

LED | 10W | 1100lm |  
CRI ≥ 90 |  
weight/waga: 2,9kg |  
box/karton:  
370x370x120mm |

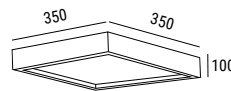

LED | 20W | 2240lm |  
CRI ≥ 90 |  
weight/waga: 2,9kg |  
box/karton:  
370x370x120mm |

**M00550** E . K C . **0**

**M00560** E K C **0**

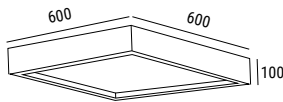

LED | 32W | 4000lm |  
CRI ≥ 90 |  
weight/waga: 2,9kg |  
box/karton:  
620x620x120mm |

**M00570** E . K C . **0**

## Finishes

### Wykończenia

**E K C**

#### Colour / Kolor

01 – white   biały
02 – black   czarny
03 – grey   szary
04 – gold   złoty
05 – white / black   biały / czarny
06 – black / white   czarny / biały
07 – black / gold   czarny / złoty
08 – gold / black   złoty / czarny
09 – grey / black   szary / czarny
10 – black / grey   czarny / szary

#### Colour temperature / Temperatura barwowa

30 – 3000K
40 – 4000K

#### Electronics / Elektronika

O – ON/OFF
D – DALI
C – CASAMBI



01 white  
01 biały



05 white outside/black inside  
05 biały zewnętrzny/czarny wewnętrzny



09 grey outside/black inside  
09 szary zewnętrzny/czarny wewnętrzny



02 black  
02 czarny



06 black outside/white inside  
06 czarny zewnętrzny/biały wewnętrzny



10 black outside/grey inside  
10 czarny zewnętrzny/szary wewnętrzny



03 grey  
03 szary



07 black outside/gold inside  
07 czarny zewnętrzny/złoty wewnętrzny



04 gold  
04 złoty



08 gold outside/black inside  
08 złoty zewnętrzny/czarny wewnętrzny

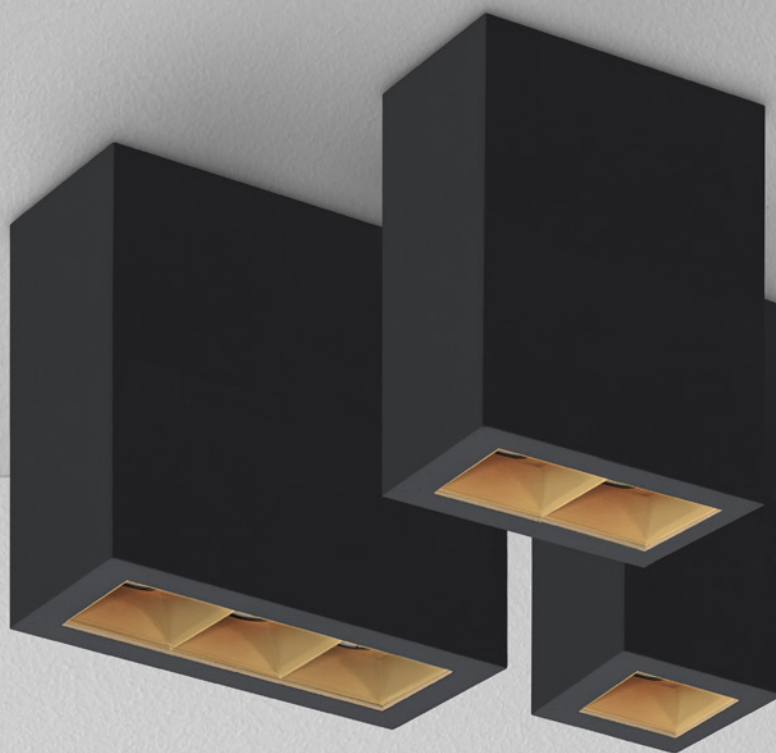

## NEAT MD

The surface version of the Neat luminaire will be an adequate choice for offices, hotels, restaurants, or home interiors. The minimalistic design will work wherever modern style plays a major role. Equipped with optics with an anti-glare screen, which provides glare rating  $UGR < 19$ , perfectly fits in spaces where lighting is used for long hours.

Oprawa Neat w wersji nastropowej będzie odpowiednim wyborem dla biur, hoteli, restauracji czy wnętrz mieszkalnych. Minimalistyczny design sprawdzi się wszędzie tam, gdzie nowoczesna stylistyka odgrywa ważną rolę. Wyposażona w optykę z przesłoną antyolśnieniową, która zapewnia wskaźnik olśnienia  $UGR < 19$ , idealnie nadaje się do pomieszczeń, w których oświetlenia używa się przez wiele godzin.

# NEAT MD

IP 20 CE  

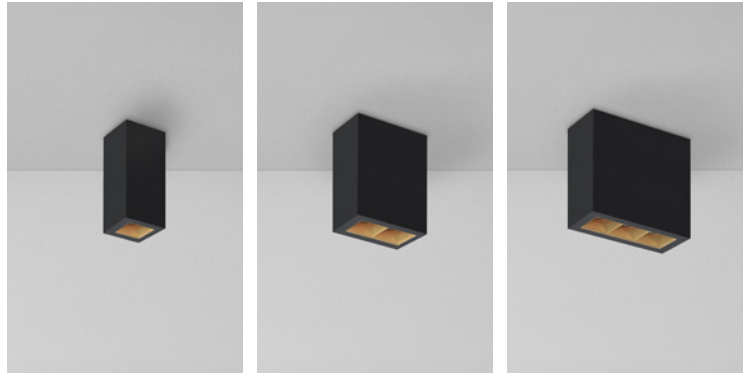

## Options

Opcje



LED | 2W | 260lm |  
CRI ≥ 90 | UGR < 19 |  
weight/waga: 0,4kg |  
box/karton:  
120x100x120mm |

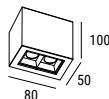

LED | 4W | 520lm |  
CRI ≥ 90 | UGR < 19 |  
weight/waga: 0,6kg |  
box/karton:  
120x100x120mm |

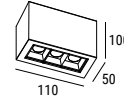

LED | 6W | 780lm |  
CRI ≥ 90 | UGR < 19 |  
weight/waga: 0,7kg |  
box/karton:  
120x120x120mm |

**M00220 . K C . L**

**M00230 . K C . L**

**M00240 . K C . L**

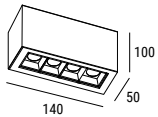

LED | 8W | 1040lm |  
CRI ≥ 90 | UGR < 19 |  
weight/waga: 0,8kg |  
box/karton:  
200x120x120mm |

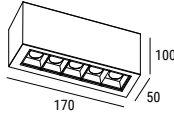

LED | 10W | 1300lm |  
CRI ≥ 90 | UGR < 19 |  
weight/waga: 1kg |  
box/karton:  
200x120x120mm |

**M00250 . K C . L**

**M00260 . K C . L**

## Finishes

Wykończenia



## Optics

Optyka



10°



25°



40°



60°

K	C	L
		<b>Optics / Optyka</b>
		10 – 10°
		25 – 25°
		40 – 40°
		60 – 60°
		<b>Colour / Kolor</b>
		01 – white   biały
		02 – black   czarny
		03 – grey   szary
		04 – gold   złoty
		05 – white / black   biały / czarny
		06 – black / white   czarny / biały
		07 – black / gold   czarny / złoty
		08 – gold / black   złoty / czarny
		09 – grey / black   szary / czarny
		10 – black / grey   czarny / szary
		<b>Colour temperature / Temperatura barwowa</b>
		27 – 2700K
		30 – 3000K
		40 – 4000K



## CAPS MD60

The Caps MD60 lamp impresses with its precision. Its shape complements the modern interiors stunningly. It is available in three sizes and four colour variants. It looks amazingly single as well as in combination with other lamps from Caps family.

Lampa Caps MD60 zachwyca precyzją wykonania. Jej kształt olśniewająco dopełni nowoczesne wnętrza. Jest dostępna w trzech rozmiarach oraz czterech wariantach kolorystycznych. Zdumiewająco prezentuje się w pojedynkę, jak i w połączeniu z innymi lampami z rodziny Caps.



# CAPS MD60

IP 20 CE  



## Options

Opcje

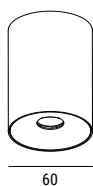

LED | 6W | 545lm |  
CRI ≥ 90 |  
weight/waga: 0,3kg |  
box/karton:  
120x120x120mm |

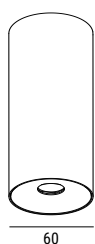

LED | 6W | 545lm |  
CRI ≥ 90 |  
weight/waga: 0,5kg |  
box/karton:  
100x100x220mm |

**M00370.** K C . L

**M00380.** K C . L

## Finishes

Wykończenia

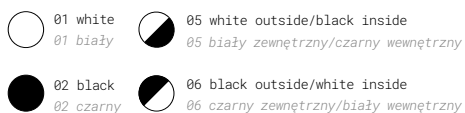

## Optics

Optyka



20°



36°



60°

K	C	L
		Optics / Optyka
		20 – 20°
		36 – 36°
		60 – 60°
		Colour / Kolor
		01 – white   biały
		02 – black   czarny
		05 – white / black   biały / czarny
		06 – black / white   czarny / biały
		Colour temperature / Temperatura barwowa
		27 – 2700K
		30 – 3000K
		40 – 4000K



## CAPS MD100

Caps MD100 will certainly fit into the tastes of those who appreciate minimalism. It is available in three sizes, which makes it possible to combine it into interesting compositions. One of its interesting functions is the possibility of phase dimming. This type of lighting will undoubtedly add an extraordinary character to the interior

Caps MD100 z pewnością wpisze się w gusta osób ceniących sobie minimalizm. Jest dostępna w trzech rozmiarach, co daje możliwość łączenia jej w ciekawe kompozycje. Jedną z jej interesujących funkcji jest możliwość ściemniania fazowego. Taki rodzaj oświetlenia bez wątpienia doda wnętrzu nieprzeciętnego charakteru.

# CAPS MD100

IP 20 CE  

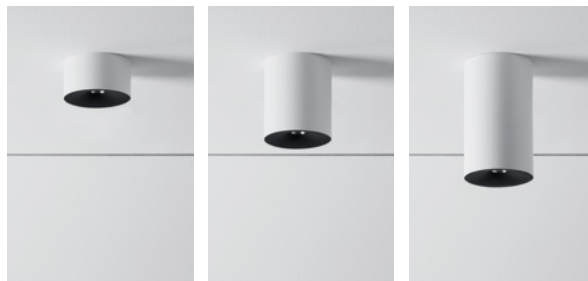

## Options

Opcje

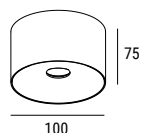

LED | 10W | 900lm |  
CRI ≥ 90 |  
weight/waga: 0,3kg |  
box/karton:  
120x120x120mm |

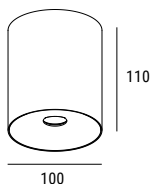

LED | 10W | 900lm |  
CRI ≥ 90 |  
weight/waga: 0,6kg |  
box/karton:  
120x120x120mm |

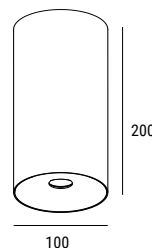

LED | 10W | 900lm |  
CRI ≥ 90 |  
weight/waga: 0,8kg |  
box/karton:  
100x100x220mm |

**M00390** . K C . L

**M00400** . K C . L

**M00410** . K C . L

## Finishes

Wykończenia

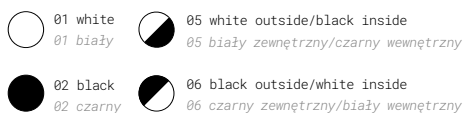

## Optics

Optyka



20°



36°



60°

K	C	L
		Optics / Optyka
		20 – 20°
		36 – 36°
		60 – 60°
		Colour / Kolor
		01 – white   biały
		02 – black   czarny
		05 – white / black   biały / czarny
		06 – black / white   czarny / biały
		Colour temperature / Temperatura barwowa
		27 – 2700K
		30 – 3000K
		40 – 4000K



# STRAW

Straw is a simple form that provides light where it is needed, enriching the space. Elegant and modern design make this suspended luminaire perfect for modern interiors. They can be successfully used to illuminate selected places in the living room, bedroom, hall or kitchen. The luminaire is made of high-quality steel with a replaceable light source with GU10 fitting. The recessed light source reduces the glare effect.

Straw to prosta forma, która dostarcza światło tam, gdzie jest potrzebne, wzbogacając przestrzeń. Elegancki i nowoczesny wygląd sprawiają, że ta oprawa wisząca idealnie nadaje się do nowoczesnych wnętrz. Z powodzeniem można je zastosować do oświetlenia wybranych miejsc w salonie, sypialni, przedpokoju czy kuchni. Oprawa wykonana jest z wysokiej jakości stali z wymiennym źródłem na trzonek GU10. Cofnięte źródło światła niweluje efekt olśnienia.

# STRAW

IP 20 CE  



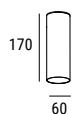

## Options

Opcje

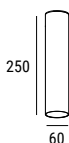

LED | GU10 | max 8W |   
weight/waga: 0,4kg |  
box/karton:  
70x70x190mm |



LED | GU10 | max 8W |   
weight/waga: 0,6kg |  
box/karton:  
70x70x270mm |



LED | GU10 | max 8W |   
weight/waga: 0,9kg |  
box/karton:  
70x70x420mm |

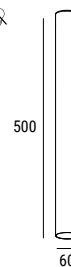

LED | GU10 | max 8W |   
weight/waga: 1,1kg |  
box/karton:  
70x70x520mm |

M00460 . 0 C . 0

M00470 . 0 C . 0

M00480 . 0 C . 0

M00490 . 0 C . 0

## Finishes

Wykończenia

C

Colour / Kolor

01 - white | biały

02 - black | czarny

03 - grey | szary

04 - gold | złoty



01 white  
01 biały



03 grey  
03 szary



02 black  
02 czarny



04 gold  
04 złoty



## STRAW 2C

Straw 2C is characterized by a simple and functional design. The luminaire fits in with contemporary lighting trends. It is possible to use several color variations, which will allow for an even more interesting arrangement of the designed interior.

Straw 2C charakteryzuje się prostym a zarazem funkcjonalnym designem. Oprawa wpisuje się we współczesne trendy oświetleniowe. Istnieje możliwość zastosowania kilku wariacji kolorystycznych, co pozwoli na jeszcze ciekawszą aranżację projektowanego wnętrza.

# STRAW 2C

IP 20 CE  



## Options

Opcje

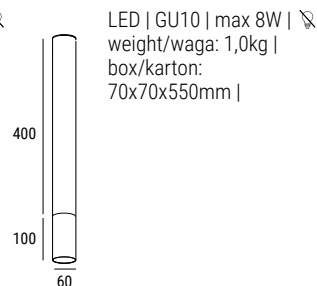
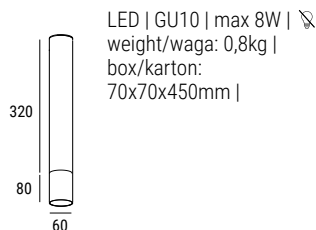
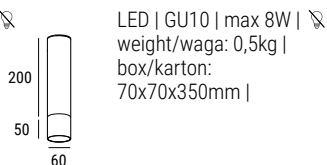
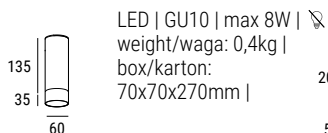

M00500 . 0 C . 0

M00510 . 0 C . 0

M00520 . 0 C . 0

M00530 . 0 C . 0

## Finishes

Wykończenia

C

Colour / Kolor

05 - white / black | biały / czarny

06 - black / white | czarny / biały

07 - black / gold | czarny / złoty

08 - gold / black | złoty / czarny

09 - grey / black | szary / czarny

10 - black / grey | czarny / szary

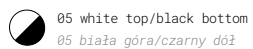



## ERO MD

The Ero luminaire suits modern trends by connecting minimalistic design with high functionality. The possibility to adjust the light beam and multiplication of the luminaire allow to illuminate the space according to individual needs. This luminaire is also characterized by its classic montage of the light source on the GU10 fitting.

Oprawa Ero wpisuje się w nowoczesne trendy, łącząc minimalistyczny design z wysoką funkcjonalnością. Możliwość regulowania kierunku strumienia światła oraz możliwość multiplikacji oprawy pozwalają na oświetlenie pomieszczeń według indywidualnych potrzeb. Oprawę Ero cechuje także źródło światła mocowane na klasyczny trzonek GU10.



# ERO MD

IP 20 CE  

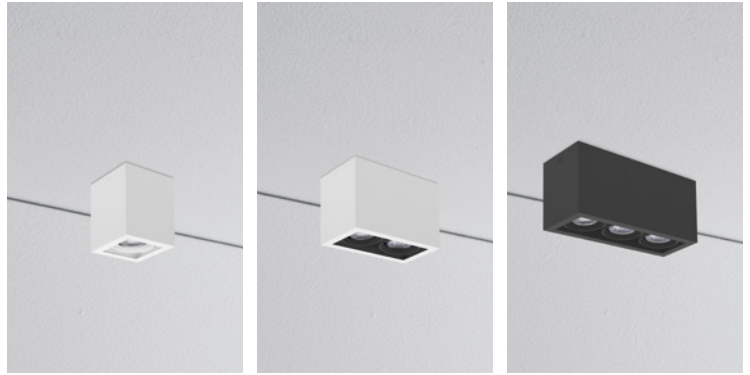

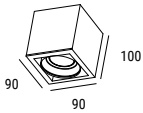

## Options

Opcje

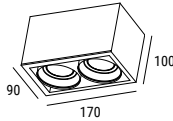

GU10 | max 50W   
weight/waga: 2kg |  
box/karton: 120x120x120mm |



GU10 | max 50W   
weight/waga: 2,8kg |  
box/karton: 200x120x120mm |

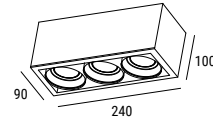

GU10 | max 50W   
weight/waga: 3,6kg |  
box/karton: 250x120x120mm |

M00270 . 0 C . 0

M00280 . 0 C . 0

M00290 . 0 C . 0

## Finishes

Wykończenia

C

Colour / Kolor

01 - white | biały

02 - black | czarny

03 - grey | szary

04 - gold | złoty

05 - white / black | biały / czarny

06 - black / white | czarny / biały

07 - black / gold | czarny / złoty

08 - gold / black | złoty / czarny

09 - grey / black | szary / czarny

10 - black / grey | czarny / szary



01 white  
01 biały



05 white outside/black inside  
05 biały zewnętrzny/czarny wewnętrzny



09 grey outside/black inside  
09 szary zewnętrzny/czarny wewnętrzny



02 black  
02 czarny



06 black outside/white inside  
06 czarny zewnętrzny/biały wewnętrzny



10 black outside/grey inside  
10 czarny zewnętrzny/szary wewnętrzny



03 grey  
03 szary



07 black outside/gold inside  
07 czarny zewnętrzny/złoty wewnętrzny



04 gold  
04 złoty



08 gold outside/black inside  
08 złoty zewnętrzny/czarny wewnętrzny



## RID MD1

The Rid MD1 ceiling lamp will add a chic to any room. Its modern design makes it ideally suited to rooms of different sizes. The choice of optics from the available 20°, 36°, 55° gives the possibility of exposing the details of a given interior. More lamps will give an amazing effect.

Lampa sufitowa Rid MD1 doda szyku każdemu pomieszczeniu. Nowoczesny design sprawia, że idealnie wkomponuje się w pomieszczenia różnej wielkości. Wybór optyki z dostępnych 20°, 36°, 55° daje możliwość wyeksponowania detali danego wnętrza. Większa ilość lamp da więc niesamowity efekt.

# RID MD1

IP 20 CE  



## Options

Opcje

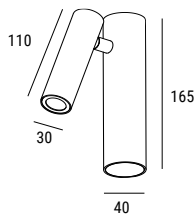

LED | 6W | 600lm |  
CRI ≥ 90 |  
weight/waga: 0,4kg |  
box/karton:  
90x140x180mm |

M00540. K C . L

K	C	L
		<b>Optics / Optyka</b>
		20 – 20°
		36 – 36°
		55 – 55°
		<b>Colour / Kolor</b>
		01 – white   biały
		02 – black   czarny
		03 – grey   szary
		04 – gold   złoty
		<b>Colour temperature / Temperatura barwowa</b>
		27 – 2700K
		30 – 3000K
		40 – 4000K

## Finishes

Wykończenia



## Optics

Optyka



20°



36°



55°

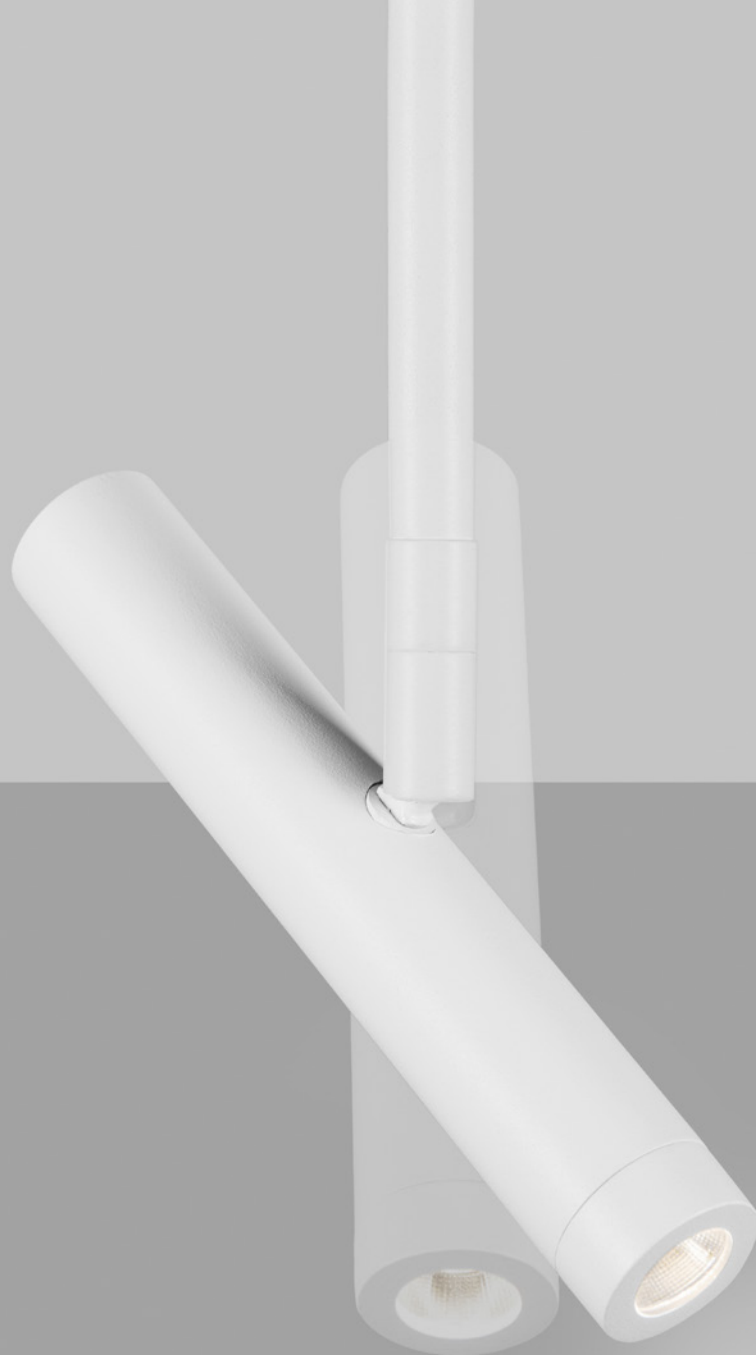

## HOLD MD1

The design of the Hold MD1 lamp is an excellent proposal for people who value minimalism and class. Elegant, simple shape will work well in modern interiors, which will fit perfectly. The spotlight can be directed in any direction, thanks to which with one movement of the lamp you can completely change the lighting in the room.

Projekt lampy Hold MD1 to doskonała propozycja dla osób ceniących minimalizm i klasę. Elegancki, prosty kształt sprawdzi się w nowoczesnych wnętrzach, do których idealnie się wpasuje. Punktowe światło skierować można w dowolną stronę, dzięki czemu za jednym ruchem lampy całkowicie zmienisz oświetlenie w pomieszczeniu.

# HOLD MD1

IP 20 CE  

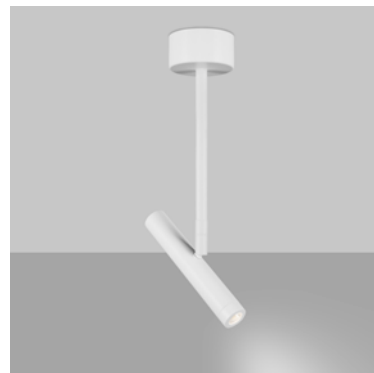

## Options

Opcje

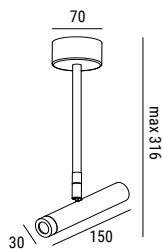

LED | 6W | 600lm |  
CRI ≥ 90 |  
weight/waga: 0,5kg |  
box/karton:  
200x100x350mm |

**M00090.** K C . L

K	C	L
		<b>Optics / Optyka</b>
		20 – 20°
		36 – 36°
		55 – 55°
		<b>Colour / Kolor</b>
		01 – white   biały
		02 – black   czarny
		03 – grey   szary
		04 – gold   złoty
		<b>Colour temperature / Temperatura barwowa</b>
		27 – 2700K
		30 – 3000K
		40 – 4000K

## Finishes

Wykończenia



## Optics

Optyka



20°



36°



55°



## SLIM

Slim, small-sized projector designed for mounting to a 3-surface track or directly to the ceiling. The luminaire is available with a replaceable light source. Slim is perfect as accent lighting, general lighting in both residential and office spaces.

Slim projektor o niewielkich rozmiarach przeznaczony do montażu do szyny 3-fazowej lub bezpośrednio do stropu. Oprawa dostępna z wymiennym źródłem światła. Slim sprawdzi się jako oświetlenie akcentujące, oświetlenie ogólne w przestrzeniach zarówno mieszkalnych jak i biurowych.

# SLIM

IP 20 CE  



## Options

Opcje

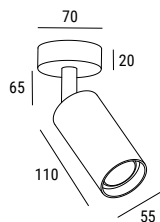

LED | GU10 | max. 8W |   
weight/waga: 0,2kg |  
box/karton:  
120x70x240mm |

M00350.0 <sup>C</sup>.0

C

Colour / Kolor

01 - white | biały

02 - black | czarny

03 - grey | szary

04 - gold | złoty

## Finishes

Wykończenia



01 white  
01 biały



03 grey  
03 szary



02 black  
02 czarny



04 gold  
04 złoty



## NOK MD1

Two tubes, connected together at an angle, form an interesting composition: one of them is used to mount the luminaire on the ceiling and at the same time it is a base for the second tube which is a reflector. They are perfect for rooms with minimalist style. This project will surely appeal to fans of original lighting.

Dwie połączone ze sobą pod kątem tuby, tworzą ciekawą dla oka kompozycję: jedna z nich służy do zamontowania oprawy na suficie i równocześnie pełni rolę podstawy dla drugiej tuby będącej reflektorem. Doskonale nadają się do pomieszczeń urządzonych w minimalistycznym stylu. Projekt ten z pewnością spodoba się fanom niebanalnego oświetlenia.



# NOK MD1

IP 20 CE  



## Options

Opcje

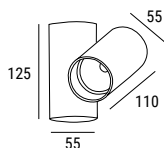

LED | 6W | 530lm |  
CRI ≥ 90 |  
weight/waga: 0,4kg |  
box/karton:  
150x150x120mm |

**M00440 . K C . L**

K	C	L
		Optics / Optyka
		30 – 30°
		50 – 50°
		Colour / Kolor
		01 – white   biały
		02 – black   czarny
		03 – grey   szary
		04 – gold   złoty
		Colour temperature / Temperatura barwowa
		27 – 2700K
		30 – 3000K
		40 – 4000K

## Finishes

Wykończenia



## Optics

Optyka



30°



50°

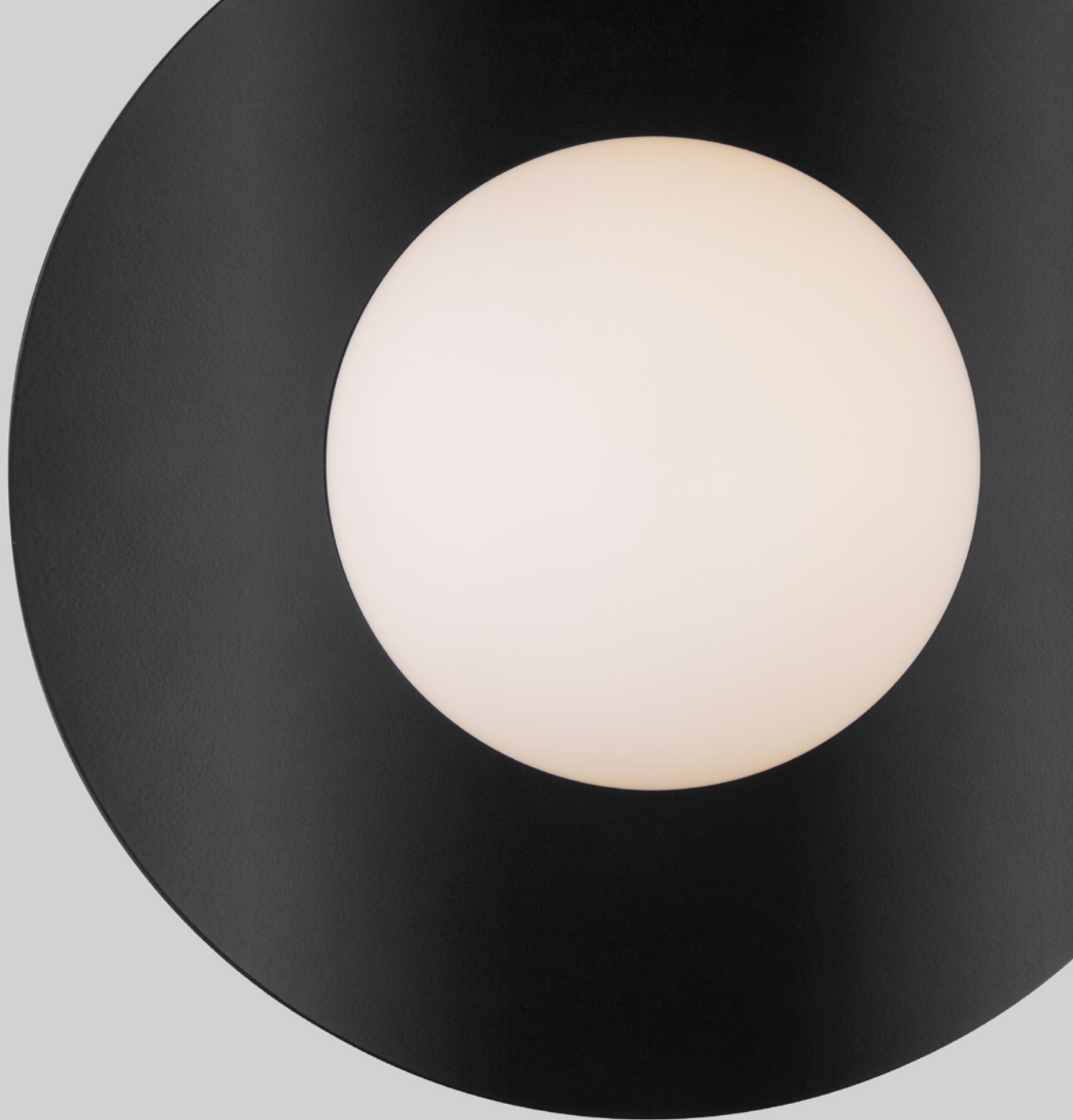

## SUN MD1

Do you dream of a sunny interior? The Sun MD1 lamp will make it possible. Mounted on a circle, the luminous sphere perfectly resembles the sun. If you care about the cosy effect, you can choose the warm colour of light in the lamp. This original design will satisfy the tastes of those who appreciate simplicity in the interior.

Marzy ci się słoneczne wnętrze? Lampa Sun MD1 to umożliwi. Zamontowana na kręgu świetlista kula idealnie przypomina słońce. Jeśli zależy Ci na efekcie przytulności, skorzystaj z możliwości wyboru ciepłej barwy światła w lampie. Ten oryginalny projekt zadowoli gusta osób ceniących prostotę we wnętrzu.

# SUN MD1

IP 20 CE  



## Options

Opcje

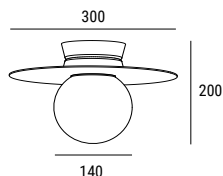

LED | 8W | 500lm |  
CRI ≥ 90 |  
weight/waga: 2,1kg |  
box/karton:  
320x320x220mm |

M00450 . K C . 0

## Finishes

Wykończenia

**K**

**C**

Colour / Kolor

01 - white | biały

02 - black | czarny

03 - grey | szary

04 - gold | złoty

Colour temperature / Temperatura barwowa

27 - 2700K

30 - 3000K

40 - 4000K



01 white  
01 biały



03 grey  
03 szary



02 black  
02 czarny



04 gold  
04 złoty



**suspended / zwieszane**

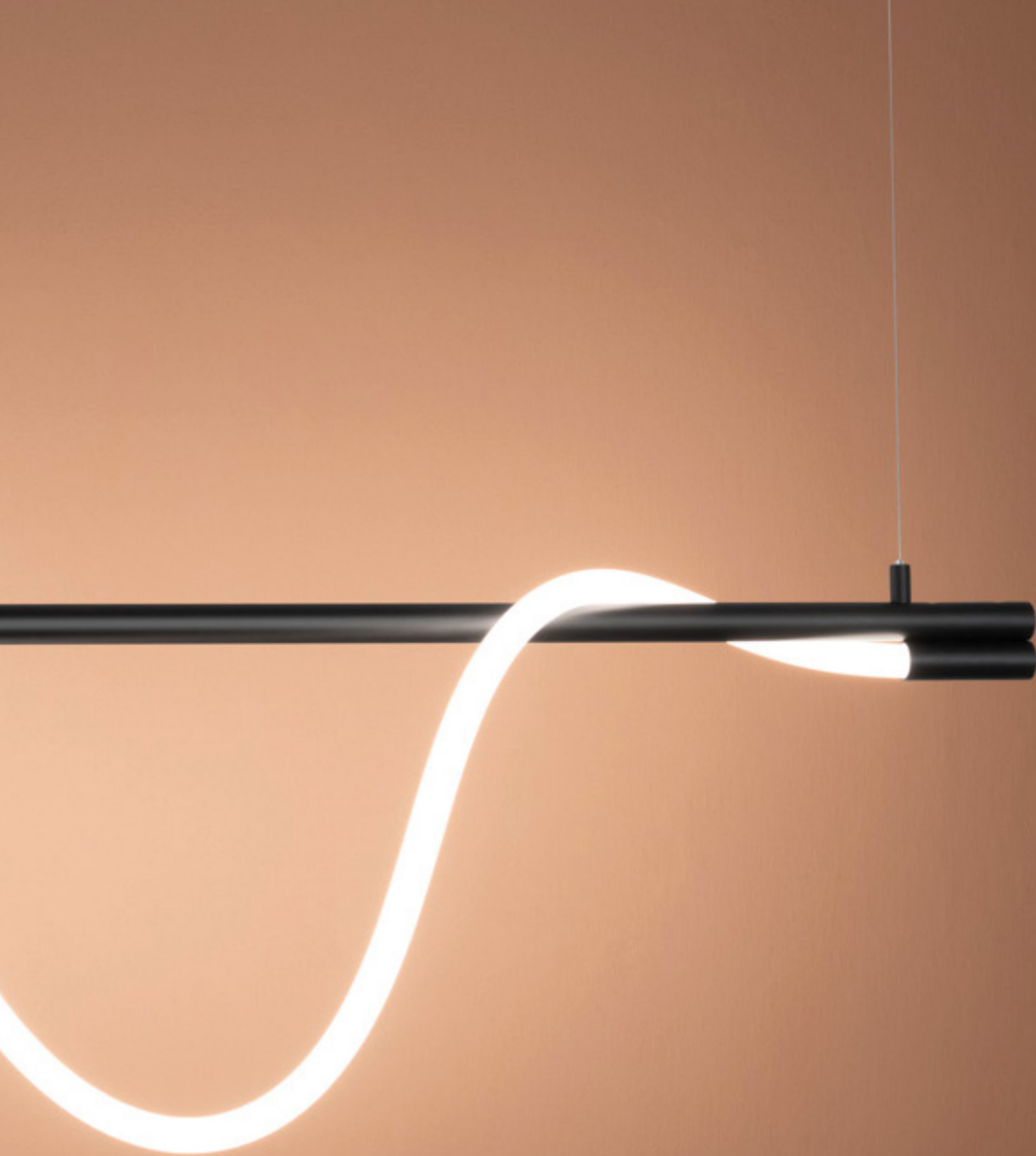

## SPRITZER

Spritzer is a lamp with dynamic, flowing shapes. Closed in a flexible tube, the light spreads gently along the designated lines. This elegant luminaire perfectly cooperates with a group of luminaires of the same type, creating unique light constellations.

Spritzer to lampa o dynamicznych, płynnych kształtach. Zamknięte w elastycznej tubie światło rozchodzi się delikatnie wzdłuż wyznaczonych linii. Ta elegancka oprawa idealnie współpracuje w grupie opraw tego samego rodzaju tworząc niepowtarzalne konstelacje świetlne.

# SPRITZER

IP 20 CE  



## Options

Opcje

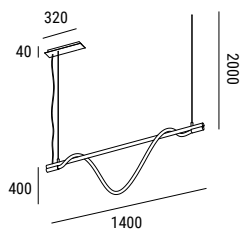

LED | 34W | 1900lm |  
CRI ≥ 90 |  
weight/waga: 3,4kg |  
box/karton:  
1500x400x100mm |

**S0043** E . K C . 0

## Finishes

Wykończenia



**E** **K** **C**

### Colour / Kolor

01 - white | biały

02 - black | czarny

03 - grey | szary

04 - gold | złoty

### Colour temperature / Temperatura barwowa

27 - 2700K

30 - 3000K

40 - 4000K

TW - Tunable White

(only with Casambi/tylko w Casambi)

### Electronics / Elektronika

O - ON/OFF

D - DALI

C - CASAMBI



## SPRITZER BRASS

Spritzer is a lamp with dynamic, flowing shapes. Closed in a flexible tube, the light spreads gently along the designated lines. This elegant luminaire perfectly cooperates with a group of luminaires of the same type, creating unique light constellations.

Spritzer to lampa o dynamicznych, płynnych kształtach. Zamknięte w elastycznej tubie światło rozchodzi się delikatnie wzdłuż wyznaczonych linii. Ta elegancka oprawa idealnie współpracuje w grupie opraw tego samego rodzaju tworząc niepowtarzalne konstelacje świetlne.



# SPRITZER BRASS

IP20 CE  



## Options

Opcje

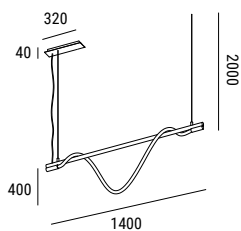

LED | 34W | 1900lm |  
CRI ≥ 90 |  
weight/waga: 3,4kg |  
box/karton:  
1500x400x100mm |

**S0043** E . K 11 . 0

## Finishes

Wykończenia

**E K**

Colour temperature / Temperatura barwowa

27 - 2700K

30 - 3000K

40 - 4000K

TW - Tunable White  
(only with Casambi/tylko w Casambi)

Electronics / Elektronika

O - ON/OFF

D - DALI

C - CASAMBI



11 brass  
11 mosiądz



# SPRITZER

Spritzer is a lamp with dynamic, flowing shapes. Closed in a flexible tube, the light spreads gently along the designated lines. This elegant luminaire perfectly cooperates with a group of luminaires of the same type, creating unique light constellations.

Spritzer to lampa o dynamicznych, płynnych kształtach. Zamknięte w elastycznej tubie światło rozchodzi się delikatnie wzdłuż wyznaczonych linii. Ta elegancka oprawa idealnie współpracuje w grupie opraw tego samego rodzaju tworząc niepowtarzalne konstelacje świetlne.

# SPRITZER

IP 20 CE  



## Options

Opcje

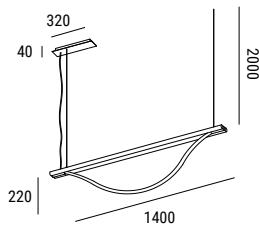

LED | 34W | 1900lm |  
CRI ≥ 90 |  
weight/waga: 4,3kg |  
box/karton:  
1500x400x100mm |

**S0062** E . K C . 0

## Finishes

Wykończenia



**E K C**

### Colour / Kolor

01 - white | biały

02 - black | czarny

03 - grey | szary

04 - gold | złoty

### Colour temperature / Temperatura barwowa

27 - 2700K

30 - 3000K

40 - 4000K

TW - Tunable White  
(only with Casambi/tylko w Casambi)

### Electronics / Elektronika

O - ON/OFF

D - DALI

C - CASAMBI



# SHADOW

Shadow is the answer for people who value simplicity in lighting. Light, circle-shaped body with a flexible tube in it, with no visible mounting elements. Delicate light emitted from the luminaire directly illuminates the space in which it is located. The luminaire is available in two diameters Ø500mm and Ø900mm

Shadow to odpowiedź dla osób ceniących prostotę w oświetleniu. Lekki korpus w kształcie koła w którym umieszczona została elastyczna tuba bez widocznych elementów montażowych. Delikatne światło wydobywające się z oprawy w sposób bezpośredni oświetla przestrzeń w której się znajduje. Oprawa występuje w dwóch średnicach fi.500mm i 900mm

# SHADOW

IP 20 CE  



## Options

Opcje

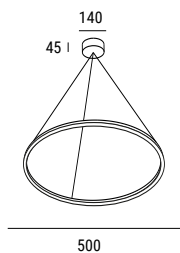

LED | 28W | 1490lm |  
CRI ≥ 90 |  
weight/waga: 2,9kg |  
box/karton:  
600x600x100mm |

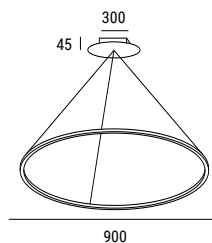

LED | 45W | 2680lm |  
CRI ≥ 90 |  
weight/waga: 3,9kg |  
box/karton:  
1000x1000x100mm |

**S0044** E . K C . 0

**S0045** E . K C . 0

## Finishes

Wykończenia



E	K	C
<b>Colour / Kolor</b>		
01 - white   biały		
02 - black   czarny		
03 - grey   szary		
04 - gold   złoty		
<b>Colour temperature / Temperatura barwowa</b>		
27 - 2700K		
30 - 3000K		
40 - 4000K		
TW - Tunable White (only with Casambi/tylko w Casambi)		
<b>Electronics / Elektronika</b>		
0 - ON/OFF		
C - CASAMBI		

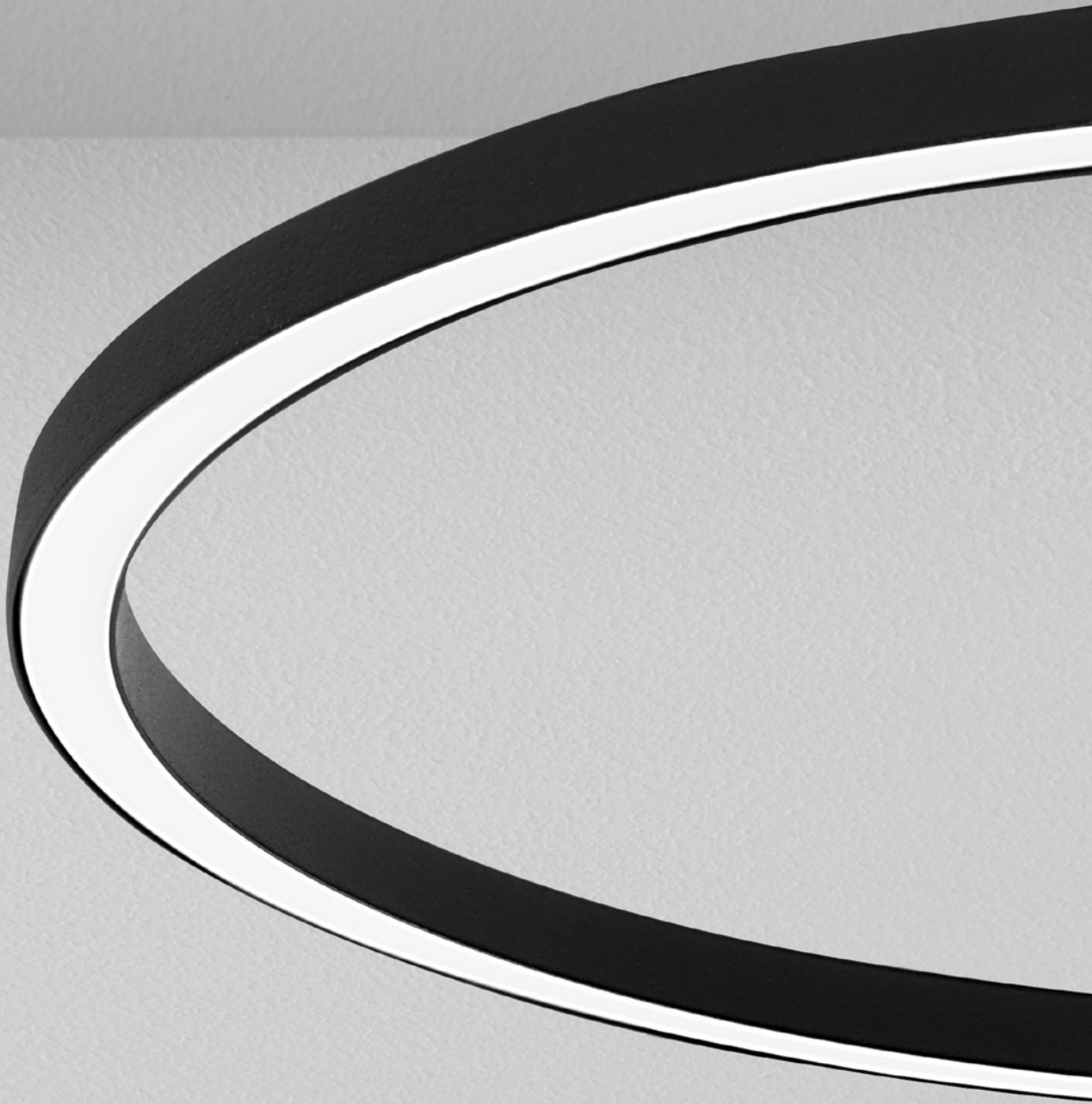

## STAR SD1

The Star SD lamp, which will work perfectly in any interior. It will ideally fill modern spaces and give them an original feel. It has the shape of a circle, which looks perfect on its own and also with other lamps. Star will create an unprecedented decoration in every house, even when it is switched off.

Lampa Star SD, która doskonale sprawdzi się w każdym wnętrzu. Idealnie wypełni nowoczesne przestrzenie i nada im oryginalnego wydziwisku. Ma kształt okręgu, który doskonale wygląda w pojedynkę, a także z innymi lampami. Star stworzy niespotykaną dekorację w każdym domu, nawet kiedy będzie wyłączona.

# STAR SD1

IP 20 CE  



## Options

Opcje

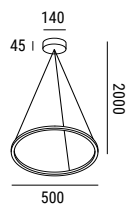

LED | 12W | 800lm |  
CRI ≥ 90 |  
weight/waga: 2,5kg |  
box/karton:  
600x600x100mm |

□ | 15  
15

**S0039** E . K C . 0

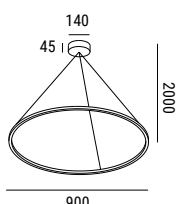

LED | 22W | 1200lm |  
CRI ≥ 90 |  
weight/waga: 3,5kg |  
box/karton:  
1000x1000x100mm |

□ | 15  
15

**S0042** E . K C . 0

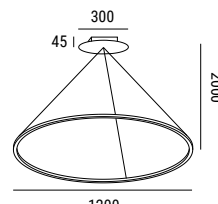

LED | 32W | 1700lm |  
CRI ≥ 90 |  
weight/waga: 4,5kg |  
box/karton:  
1300x1300x100mm |

□ | 15  
15

**S0058** E . K C . 0

## Finishes

Wykończenia

**E K C**

### Colour / Kolor

01 - white | biały

02 - black | czarny

03 - grey | szary

04 - gold | złoty

### Colour temperature / Temperatura barwowa

27 - 2700K

30 - 3000K

40 - 4000K

on request/na zapytanie:  
Tunable White - Casambi

### Electronics / Elektronika

0 - ON/OFF

C - CASAMBI



01 white  
01 biały



03 grey  
03 szary



02 black  
02 czarny



04 gold  
04 złoty



## BEE

The lamp will fit perfectly into modern, industrial interiors. Its original form attracts attention. Bee will not only perfectly illuminate the interior, but will also become an intriguing decorative element.

Lampa idealnie wpasuje się w nowoczesne, industrialne wnętrza. Uwagę przyciąga jej oryginalna forma. Bee nie tylko doskonale oświetli wnętrze, ale stanie się też intrygującym elementem dekoracyjnym.



# BEE

IP 20 CE  



## Options

Opcje

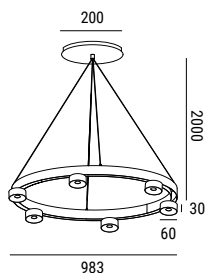

LED | 31W | 3270lm |  
CRI ≥ 90 |  
weight/waga: 11kg |  
box/karton:  
1000x1000x120mm |  
□ 35x60

**S0046** E . K C . L

## Finishes for projectors

Wykończenia projektorów

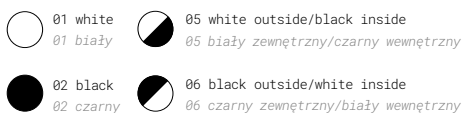

## Optics

Optyka



20°



36°



60°

E	K	C	L
			<b>Optics / Optyka</b>
			20 – 20°
			36 – 36°
			60 – 60°
			<b>Colour / Kolor</b>
			01 – white   biały
			02 – black   czarny
			05 – white / black   biały / czarny
			06 – black / white   czarny / biały
			<b>Colour temperature / Temperatura barwowa</b>
			27 – 2700K
			30 – 3000K
			40 – 4000K
			<b>Electronics / Elektronika</b>
			O – ON/OFF
			D – DALI

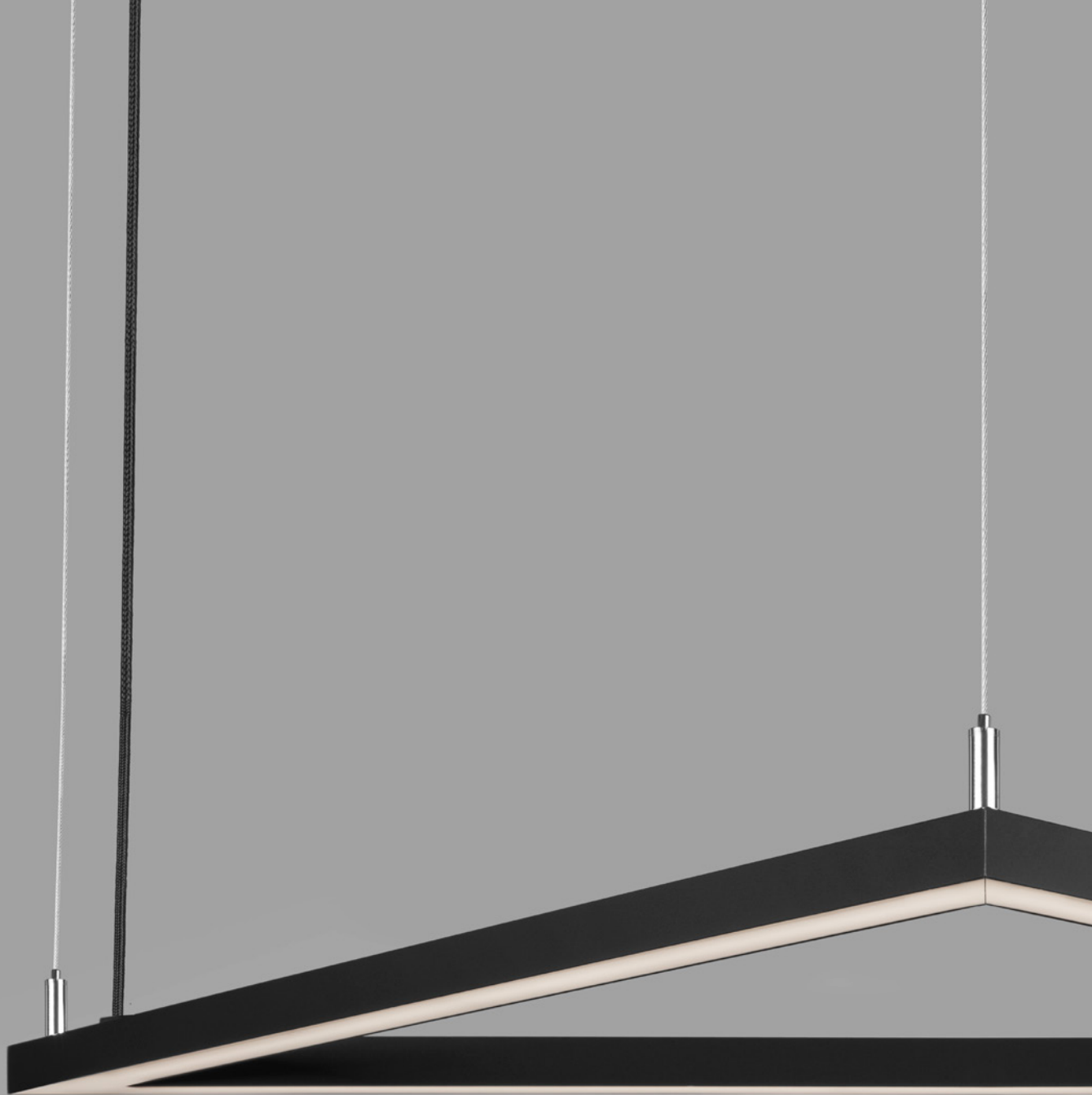

# SAMOS

Samos is a functional lamp and original decoration in one. Its minimalist but intriguing design will fit the tastes of modern style lovers. The geometric shape of Samos will attract attention and intrigue. The design, colours and light of the lamp will bring a unique atmosphere to the interior.

Samos to funkcjonalna lampa i oryginalna ozdoba w jednym. Jej minimalistyczny, ale intrygujący design wpisze się w gusta miłośników stylu nowoczesnego. Geometryczny kształt modelu Samos zwróci uwagę i zaintryguje. Wykonanie, kolorystyka oraz światło lampy wprowadzą do wnętrza wyjątkowy klimat.

# SAMOS

IP 20 CE  



## Options

Opcje

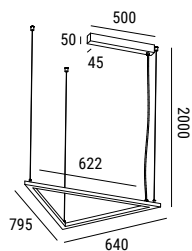

LED | 20W | 2000lm |  
CRI ≥ 90 |  
weight/waga: 2,3kg |  
box/karton:  
820x820x170mm |  
□ 20x25

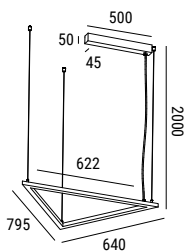

LED | 40W | 4000lm |  
CRI ≥ 90 |  
weight/waga: 2,3kg |  
box/karton:  
820x820x170mm |  
□ 20x25

**S0005** E . K C . 0

**S0028** E . K C . 0

## Finishes

Wykończenia

**E K C**

### Colour / Kolor

01 - white | biały

02 - black | czarny

03 - grey | szary

04 - gold | złoty

### Colour temperature / Temperatura barwowa

30 - 3000K

40 - 4000K

### Electronics / Elektronika

0 - ON/OFF

D - DALI



01 white  
01 biały



03 grey  
03 szary



02 black  
02 czarny



04 gold  
04 złoty

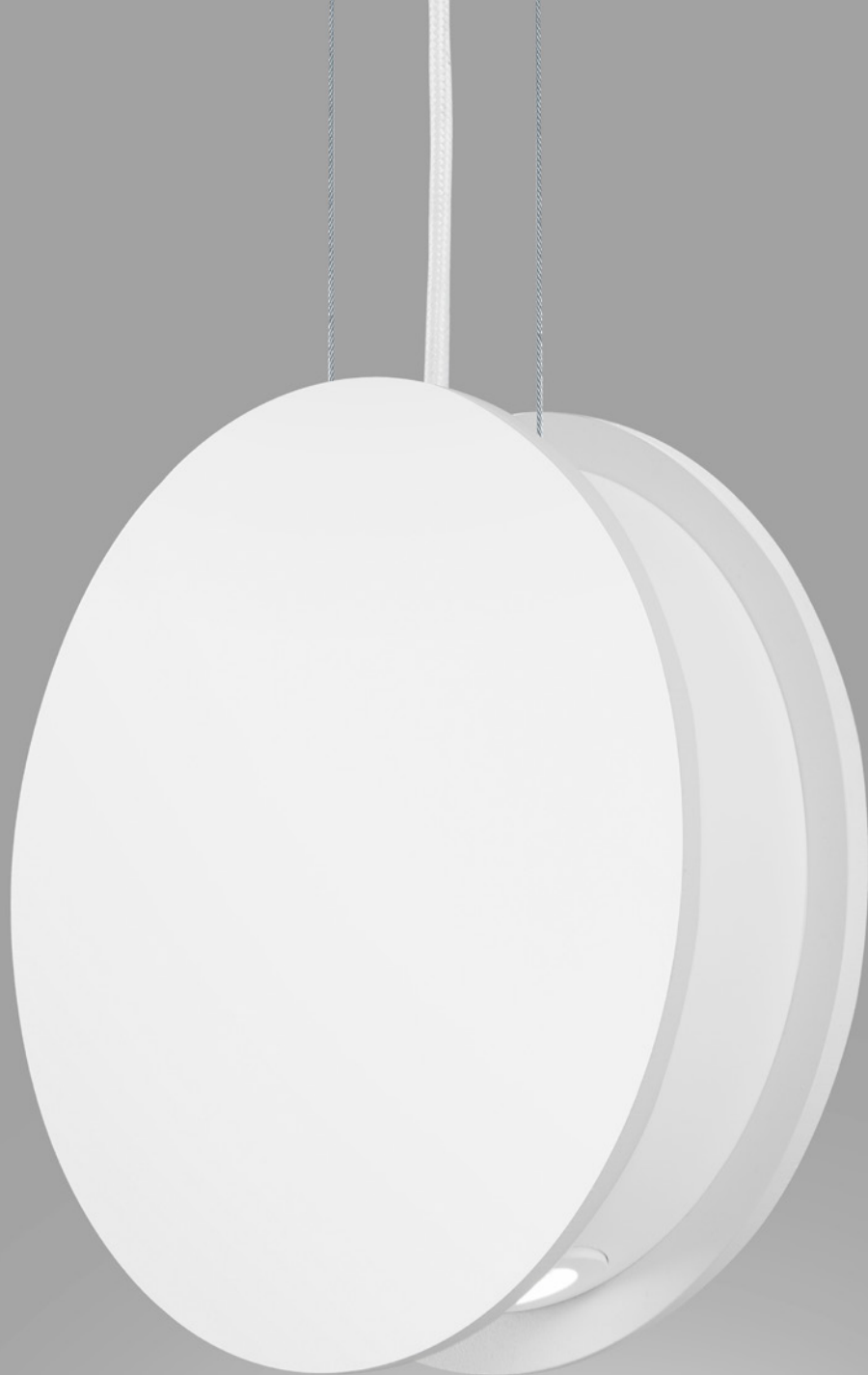

# IGNIS

The Ignis lamp is a sophisticated solution that can change any interior. The design with a circle motif will look great in both modern and classic interiors. The lamp will enchant you with its atmospheric light, simplicity and unique construction. It will meet the expectations of the greatest perfectionists.

Lampa Ignis to wyszukane rozwiązanie, które potrafi odmienić każde wnętrze. Projekt z motywem koła będzie prezentował się świetnie zarówno w nowoczesnych, jak i klasycznych wystrojach. Lampa zauroczy nastrojowym światłem, prostotą oraz unikalną konstrukcją. Spełni oczekiwania największych perfekcjonistów.

# IGNIS

IP 20 CE  



## Options

Opcje

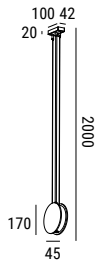

LED | 6W | 600lm |  
CRI ≥ 90 |  
weight/waga: 1,6kg |  
box/karton:  
220x220x120mm |

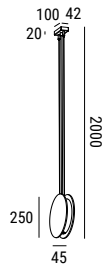

LED | 6W | 600lm |  
CRI ≥ 90 |  
weight/waga: 2,6kg |  
box/karton:  
280x280x120mm |

**S00080 . K . C . L**

**S00070 . K . C . L**

## Finishes

Wykończenia



K	C	L
<b>Optics / Optyka</b>		
20 – 20°		
36 – 36°		
55 – 55°		
<b>Colour / Kolor</b>		
01 – white   biały		
02 – black   czarny		
03 – grey   szary		
04 – gold   złoty		
<b>Colour temperature / Temperatura barwowa</b>		
27 – 2700K		
30 – 3000K		
40 – 4000K		

## Optics

Optyka



20°



36°



55°



## CAPS SD

Caps SD is an option for supporters of minimalist and striking design elements. This hanging lamp will not only illuminate the interior, but will also give it a unique character. Its universal shape will suit every room.

Caps SD to opcja dla zwolenników minimalistycznych, a także efektownych elementów wystroju. Ta lampa wisząca nie tylko oświetli wnętrze, ale i doda mu nieprzeciętnego charakteru. Jej uniwersalny kształt dopasuje się do każdego pomieszczenia.

# CAPS SD

IP 20 CE  



## Options

Opcje

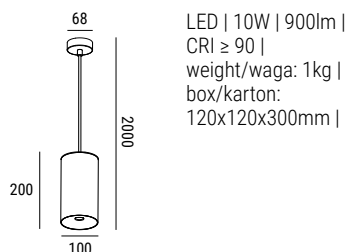
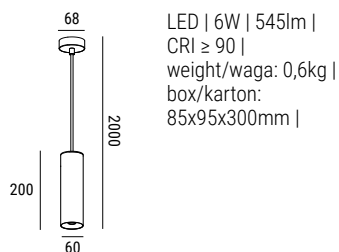

S0047 E . K C . L

S0048 E . K C . L

## Finishes

Wykończenia

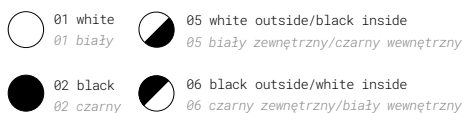

## Optics

Optyka



20°



36°



60°

E	K	C	L
			<b>Optics / Optyka</b>
			20 – 20°
			36 – 36°
			60 – 60°
			<b>Colour / Kolor</b>
			01 – white   biały
			02 – black   czarny
			05 – white / black   biały / czarny
			06 – black / white   czarny / biały
			<b>Colour temperature / Temperatura barwowa</b>
			27 – 2700K
			30 – 3000K
			40 – 4000K
			<b>Electronics / Elektronika</b>
			O – ON/OFF
			D – DALI



# CUT

The Cut lamp will impress at first glance. It will look very impressive, will add chic and will attract the attention of the household members, but also guests. It will perfectly complement the modern interior design. By using several Cut models you will achieve a phenomenal lighting and decorative effect.

Lampa Cut zachwyci już na pierwszy rzut oka. Będzie prezentować się niezwykle efektownie, doda szycu oraz przykuje uwagę domowników, ale również gości. Doskonale uzupełni wystrój nowoczesnego wnętrza. Stosując kilka modeli Cut, osiągniesz zjawiskowy efekt oświetleniowy i dekoracyjny.



# CUT

IP 20 CE  



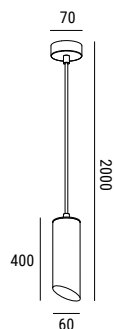

## Options

Opcje

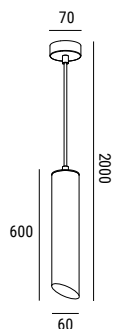

LED | GU10 | max 8W |   
weight/waga: 1,2kg |  
box/karton:  
85x95x500mm |



LED | GU10 | max 8W |   
weight/waga: 1,4kg |  
box/karton:  
85x95x600mm |

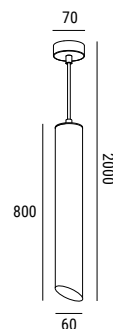

LED | GU10 | max 8W |   
weight/waga: 1,6kg |  
box/karton:  
85x95x900mm |

S00140 . 0 C . 0

S00150 . 0 C . 0

S00160 . 0 C . 0

## Finishes

Wykończenia

**C**

Colour / Kolor

01 - white | biały

02 - black | czarny

03 - grey | szary

04 - gold | złoty



01 white  
01 biały



03 grey  
03 szary



02 black  
02 czarny



04 gold  
04 złoty



# STRAW

A simple form that provides light where it is needed, enriching the space. Elegant and modern design make this suspended luminaire perfect for modern interiors. They can be successfully used to illuminate selected places in the living room, bedroom, hall or kitchen. The luminaire is made of high-quality steel with a replaceable light source with GU10 fitting. The recessed light source reduces the glare effect.

Prosta forma, która dostarcza światło tam, gdzie jest potrzebne, wzbogacając przestrzeń. Elegancki i nowoczesny wygląd sprawiają, że ta oprawa wisząca idealnie nadaje się do nowoczesnych wnętrz. Z powodzeniem można je zastosować do oświetlenia wybranych miejsc w salonie, sypialni, przedpokoju czy kuchni. Oprawa wykonana jest z wysokiej jakości stali z wymiennym źródłem na trzonek GU10. Cofnięte źródło światła niweluje efekt olśnienia.

# STRAW

IP20 CE  



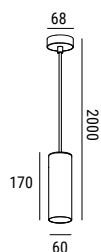

## Options

Opcje

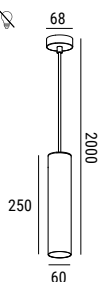

LED | GU10 | max 8W |   
weight/waga: 0,5kg |  
box/karton:  
70x70x270mm |



LED | GU10 | max 8W |   
weight/waga: 0,7kg |  
box/karton:  
70x70x350mm |

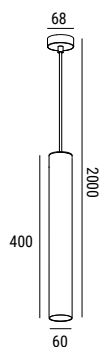

LED | GU10 | max 8W |   
weight/waga: 1,2kg |  
box/karton:  
70x70x450mm |

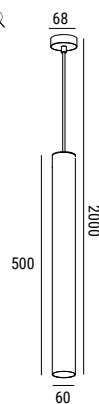

LED | GU10 | max 8W |   
weight/waga: 1,4kg |  
box/karton:  
70x70x550mm |

S00500 . 0 C . 0

S00510 . 0 C . 0

S00520 . 0 C . 0

S00530 . 0 C . 0

## Finishes

Wykończenia

C

Colour / Kolor

01 - white | biały

02 - black | czarny

03 - grey | szary

04 - gold | złoty



01 white  
01 biały



03 grey  
03 szary



02 black  
02 czarny



04 gold  
04 złoty



## STRAW 2C

Straw 2C is characterized by a simple and functional design. The luminaire fits in with contemporary lighting trends. It is possible to use several color variations, which will allow for an even more interesting arrangement of the designed interior.

Straw 2C charakteryzuje się prostym a zarazem funkcjonalnym designem. Oprawa wpisuje się we współczesne trendy oświetleniowe. Istnieje możliwość zastosowania kilku wariacji kolorystycznych, co pozwoli na jeszcze ciekawszą aranżację projektowanego wnętrza.

# STRAW 2C

IP 20 CE  



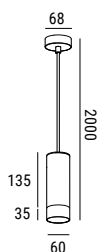

## Options

Opcje

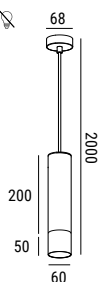

LED | GU10 | max 8W |   
weight/waga: 0,4kg |  
box/karton:  
70x70x270mm |



LED | GU10 | max 8W |   
weight/waga: 0,5kg |  
box/karton:  
70x70x350mm |

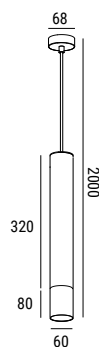

LED | GU10 | max 8W |   
weight/waga: 0,8kg |  
box/karton:  
70x70x450mm |

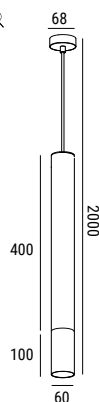

LED | GU10 | max 8W |   
weight/waga: 1,0kg |  
box/karton:  
70x70x550mm |

S00540 . 0 C . 0

S00550 . 0 C . 0

S00560 . 0 C . 0

S00570 . 0 C . 0

## Finishes

Wykończenia

**C**

Colour / Kolor

05 - white / black | biały / czarny

06 - black / white | czarny / biały

07 - black / gold | czarny / złoty

08 - gold / black | złoty / czarny

09 - grey / black | szary / czarny

10 - black / grey | czarny / szary



05 white top/black bottom  
05 biała góra/czarny dół



06 black top/white bottom  
06 czarna góra/biały dół



07 black top/gold bottom  
07 czarna góra/złoty dół



08 gold top/black bottom  
08 złota góra/czarny dół



09 grey top/black bottom  
09 szara góra/czarny dół



10 black top/grey bottom  
10 czarna góra/szary dół



## CLEAR EYE

The CLEAR EYE luminaire is an elegant luminaire which, thanks to the use of a special lens, distributes the light beam evenly on the illuminated surface. In addition to functionality, the shape and location of the lens give the frame a unique character and spice. CLEAR EYE will work in the designed interior, both in a single version or as part of a larger lighting composition.

Oprawa CLEAR EYE to elegancka oprawa, która dzięki zastosowaniu specjalnej soczewki, powoduje rozłożenie strumienia światła w równomierny sposób na oświetlanej powierzchni. Dodatkowo prócz funkcjonalności, kształt i umiejscowienie soczewki nadaje oprawie wyjątkowego charakteru i smaku. CLEAR EYE sprawdzi się w projektowanym wnętrzu zarówno w pojedynczej wersji lub jako część większej kompozycji świetlnej.

# CLEAR EYE

IP 20 CE  



## Options

Opcje

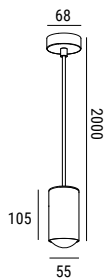

LED | GU10 | 4W |  
weight/waga: 0,5kg |  
box/karton: 70x70x150mm |

S00590 . 0 C . 0

## Finishes

Wykończenia

C

Colour / Kolor

01 - white | biały

02 - black | czarny

03 - grey | szary

04 - gold | złoty



01 white  
01 biały



03 grey  
03 szary



02 black  
02 czarny



04 gold  
04 złoty

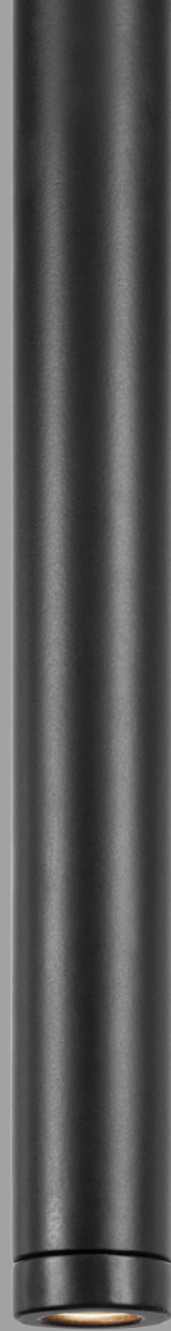

## FIT

The simplicity of this project makes it really popular. Despite its uncomplicated construction, it allows to create a remarkable arrangement. The combination of chic colours and minimalist form will emphasise the style of the interior. The lamp will look impressive on its own, but the composition of several is also an excellent idea.

Prostota tego projektu sprawia, że jego zwolenników nie brakuje. Mimo nieskomplikowanej konstrukcji, pozwala stworzyć niebanalną aranżację. Połączenie szykownej kolorystyki i minimalistycznej formy podkreśli styl wnętrza. Lampa będzie prezentować się efektownie w pojedynkę, ale kompozycja kilku to również doskonały pomysł.



# FIT

IP 20 CE  

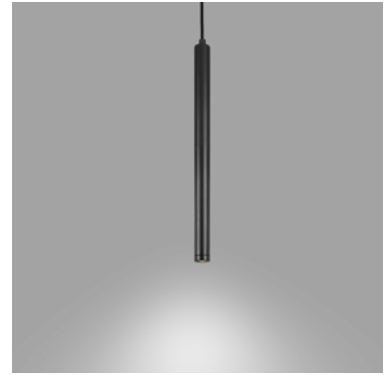

## Options

Opcje

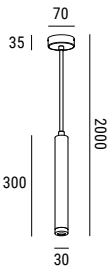

LED | 6W | 600lm |  
CRI ≥ 90 |  
weight/waga: 0,6kg |  
box/karton:  
85x95x500mm |

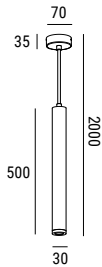

LED | 6W | 600lm |  
CRI ≥ 90 |  
weight/waga: 1kg |  
box/karton:  
85x95x600mm |

**S00120 . K . C . L**

**S00130 . K . C . L**

## Finishes

Wykończenia



## Optics

Optyka



20°



36°



55°

K	C	L
		<b>Optics / Optyka</b>
		20 – 20°
		36 – 36°
		55 – 55°
		<b>Colour / Kolor</b>
		01 – white   biały
		02 – black   czarny
		03 – grey   szary
		04 – gold   złoty
		<b>Colour temperature / Temperatura barwowa</b>
		27 – 2700K
		30 – 3000K
		40 – 4000K



## **BERO SD**

The Bero SD lamp is strongly recommended for high rooms. A long tube shaped lamp ended with LED is one element of the lamp construction. The second element is a projector placed on the side of the tube which allows to direct the light stream. Bero will be an impressive and functional decoration.

Lampa Bero SD zdecydowanie polecana do wysokich pomieszczeń. Długa oprawa w kształcie tuby zakończona oczkiem ledowym to jeden element konstrukcji lampy. Drugi element to reflektor umieszczony na boku tuby umożliwiający kierowanie strumieniem światła. Bero będzie efektowną i funkcjonalną dekoracją.

# BERO SD

IP 20 CE  



## Options

Opcje

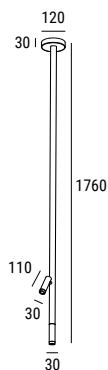

LED | 2x6W | 2x600lm |  
CRI ≥ 90 |  
weight/waga: 2,2kg |  
box/karton:  
140x140x1800mm |

S00110 . K C . L

K	C	L
		<b>Optics / Optyka</b>
		20 – 20°
		36 – 36°
		55 – 55°
		<b>Colour / Kolor</b>
		01 – white   biały
		02 – black   czarny
		03 – grey   szary
		04 – gold   złoty
		<b>Colour temperature / Temperatura barwowa</b>
		27 – 2700K
		30 – 3000K
		40 – 4000K

## Finishes

Wykończenia



## Optics

Optyka



20°



36°



55°



## POLPO

Polpo combines functionality, original form and modernity. Round shades hanging from the ceiling create an eye-catching arrangement. This solution will be a perfect solution, among others, in living rooms, where it will serve as an intriguing decoration. The lamp will light up the room and give it a charm.

Polpo łączy w sobie funkcjonalność, oryginalną formę i nowoczesność. Zwisające z sufitu okrągłe klosze tworzą przykuwający wzrok układ. To rozwiązanie świetnie sprawdzi się m.in. w salonach, gdzie spełni funkcję intrygującej dekoracji. Lampa klimatycznie oświetli pomieszczenie i doda mu uroku.

# POLPO

IP 20 CE  



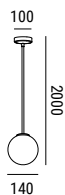

## Options

Opcje

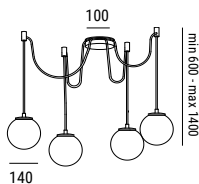

E14 | max 35W |   
weight/waga: 0,6kg |  
box/karton:  
160x160x230mm |



E14 | max 4x35W |   
weight/waga: 3,5kg |  
box/karton:  
320x320x250mm |

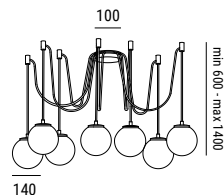

E14 | max 7x35W |   
weight/waga: 5,5kg |  
box/karton:  
470x470x250mm |

S00190 . 0 C . 0

S00290 . 0 C . 0

S00300 . 0 C . 0

## Finishes

Wykończenia

C

Colour / Kolor

01 - white | biały

02 - black | czarny

03 - grey | szary

04 - gold | złoty



01 white  
01 biały



03 grey  
03 szary



02 black  
02 czarny



04 gold  
04 złoty



## SOL GLASS

The Sol Glass lamp is a proposal for people who value simplicity and good taste. A specific trapezium-shaped lamp shade is hung on a thin, transparent wire. Sol delights with its combination of originality and functionality. It will masterfully fit into any interior.

Lampa Sol Glass to propozycja dla osób, które cenią sobie prostotę i dobry smak. Na cienkim, transparentnym przewodzie zwieszony został specyficzny klosz w kształcie trapezu. Sol zachwyca połączeniem oryginalności i funkcjonalności. Mistrzowsko wpasuje się w każde wnętrze.

# SOL GLASS

IP20 CE  



## Options

Opcje

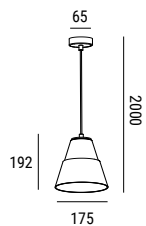

E27 | max 60W |   
weight/waga: 0,8kg |  
box/karton:  
200x200x250mm |

S00250 . 0 C . 0

## Finishes

Wykończenia

C

Colour / Kolor

01 - white | biały

02 - black | czarny

03 - grey | szary

04 - gold | złoty



01 white  
01 biały



03 grey  
03 szary



02 black  
02 czarny



04 gold  
04 złoty



# TERIA

Teria will harmonize with rooms maintained in both cool and warm colours. With this simple but elegant lamp, you can choose from the shapes of the luminaire and four colours and three sizes. The appropriate shape of the luminaire will allow you to illuminate the chosen room according to your preferences.

Teria wkomponuje się w pomieszczenia utrzymane zarówno w chłodnych, jak i ciepłych barwach. W przypadku tej prostej, ale eleganckiej lampy, wybierać można spośród kształtów oprawy oraz czterech kolorów i trzech wielkości. Odpowiednie wyprofilowanie oprawy pozwoli na oświetlenie wybranego pomieszczenia według własnych upodobań.



# TERIA

IP 20 CE  



## Options

Opcje

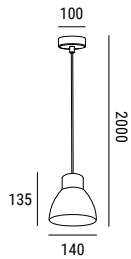

E27 | max 60W |   
weight/waga: 0,4kg |  
box/karton:  
160x160x230mm |

S00220 . 0 C . 0

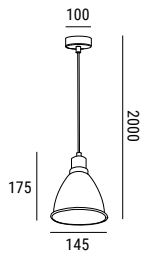

E27 | max 60W |   
weight/waga: 0,4kg |  
box/karton:  
160x160x230mm |

S00230 . 0 C . 0

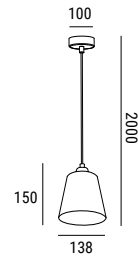

E27 | max 60W |   
weight/waga: 0,4kg |  
box/karton:  
160x160x230mm |

S00240 . 0 C . 0

C

Colour / Kolor

01 - white | biały

02 - black | czarny

03 - grey | szary

04 - gold | złoty

## Finishes

Wykończenia





# TORTA

The stylish Torta lamp is an accessory that will make your living room or dining room a completely different interior. It will be perfect for subdued and classic rooms. A metal trapezoid-shaped lamp shade allows for precise illumination of a large area. Mounting a few such lamps will change the room radically.

Stylowa lampa Torta to dodatek, który sprawi, że salon czy jadalnia stanie się zupełnie innym wnętrzem. Perfekcyjnie sprawdzi się w stonowanych oraz klasycznych pokojach. Klosz metalowy w kształcie trapezu pozwala na dokładne oświetlenie dużego obszaru danej powierzchni. Montaż kilku takich lamp diametralnie odmieni pomieszczenie.

# TORTA

IP 20 CE  



## Options

Opcje

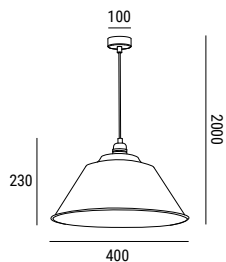

E27 | max 100W |   
weight/waga: 1kg |  
box/karton:  
420x420x280mm |

S00210.0 C.0

## Finishes

Wykończenia

**C**

Colour / Kolor

01 - white | biały

02 - black | czarny

03 - grey | szary

04 - gold | złoty



01 white  
01 biały



03 grey  
03 szary



02 black  
02 czarny



04 gold  
04 złoty



# HEXAGON

The Hexagon lamp combines classic and modern elements. The futuristic trapezium luminaire will be a perfect decorative element, matching the latest trends. Four colour variants will make it easier to match Hexagon with other design elements.

Lampa Hexagon łączy ze sobą elementy klasyki oraz nowoczesności. Futurystyczna oprawa w kształcie trapezu będzie doskonałym elementem dekoracyjnym, wpisującym się w najnowsze trendy. Cztery warianty kolorystyczne ułatwią dopasowanie Hexagon do pozostałych elementów wystroju.

# HEXAGON

IP 20 CE  



## Options

Opcje

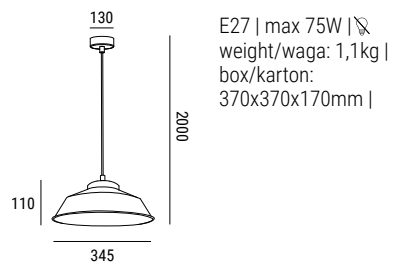

S00200 . 0 C . 0

## Finishes

Wykończenia

**C**

Colour / Kolor

01 - white | biały

02 - black | czarny

03 - grey | szary

04 - gold | złoty



01 white  
01 biały



03 grey  
03 szary



02 black  
02 czarny



04 gold  
04 złoty



## SUN SD1

The inconspicuously simple structure of the Sun SD1 lamp attracts attention in an amazing way. It is perfect for various types of rooms. Its simplicity makes it a great addition in the living room, restaurant or office. It is available in four colour variants.

Niepozornie prosta budowa lampy Sun SD1 w zadziwiający sposób przykuwa uwagę. Znakomicie sprawdzi się w pomieszczeniach różnego rodzaju. Jej prostota sprawia, że bez problemu stanie się świetnym dodatkiem zarówno w salonie, jak i restauracji czy biurze. Jest dostępna w czterech wariantach kolorystycznych.

# SUN SD1

IP 20 CE  



## Options

Opcje

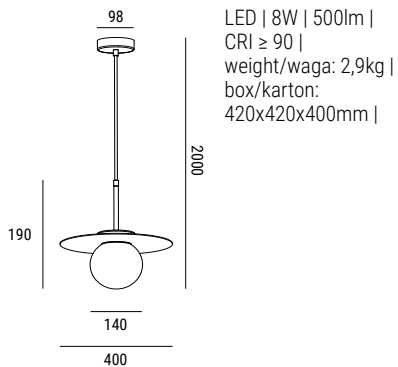

**S00490 . K C . 0**

## Finishes

Wykończenia

K	C
<b>Colour / Kolor</b>	
01 - white   biały	
02 - black   czarny	
03 - grey   szary	
04 - gold   złoty	
<b>Colour temperature / Temperatura barwowa</b>	
27 - 2700K	
30 - 3000K	
40 - 4000K	





## POP

The Pop lamp guarantees full illumination of every room. It will be appropriate both in the kitchen, as well as in the living room or bedroom, while becoming an interesting element of the decor. The luminaire is distinguished by a short tube, combined with a flat disk and the possibility of choosing a bulb in various shapes.

Lampa Pop gwarantuje pełne oświetlenie każdego pomieszczenia. Sprawdzi się zarówno w kuchni, jak i w salonie czy sypialni, stając się równocześnie ciekawym elementem wystroju. Oprawę wyróżnia krótka tuba, połączona z płaskim dyskiem oraz możliwością doboru żarówki w różnych kształtach.



# POP

IP 20 CE  



## Options

Opcje

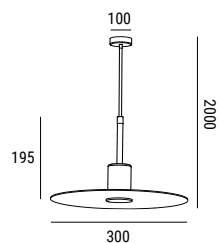

E27 | max 60W |   
weight/waga: 1,5kg  
box/karton:  
320x320x250mm |

S00180. 0 C . 0

## Finishes

Wykończenia

C

Colour / Kolor

01 - white | biały

02 - black | czarny

03 - grey | szary

04 - gold | złoty



01 white  
01 biały



03 grey  
03 szary



02 black  
02 czarny



04 gold  
04 złoty



**desk lamps / lampy biurkowe**  
**floor lamps / lampy podłogowe**



## RID DL1

The Rid DL1 lamp was designed for modern offices and bedrooms. A spotlight source will provide good illumination of selected places, e.g. a desk or a table at the bedside. The possibility of choosing the optics and colour temperature will allow you to adjust Rid to your needs.

Lampa Rid DL1 powstała z myślą o nowoczesnych gabinetach i sypialniach. Punktowe źródło światła zapewni dobre doświetlenie wybranych miejsc, np. biurka czy stolika przy łóżku. Możliwość wyboru optyki oraz temperatury barwowej, pozwoli Ci dopasować Rid do swoich potrzeb.

# RID DL1

IP 20 CE  



## Options

Opcje

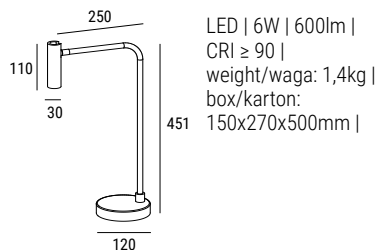

D00010 . K C . L

## Finishes

Wykończenia



## Optics

Optyka



20°



36°



55°

K	C	L
		<b>Optics / Optyka</b>
		20 – 20°
		36 – 36°
		55 – 55°
		<b>Colour / Kolor</b>
		01 – white   biały
		02 – black   czarny
		03 – grey   szary
		04 – gold   złoty
		<b>Colour temperature / Temperatura barwowa</b>
		27 – 2700K
		30 – 3000K
		40 – 4000K



## RID FL1

Rid FL1 will be a great choice for lovers of evening book reading. Simple, it does not take up much space, it will easily fit behind your favourite armchair. The spotlight of the luminaire enables precise illumination of the selected element, and the available colour temperature of the light source - warm or white - will let your eyes rest.

Rid FL1 będzie doskonałym wyborem dla miłośników wieczornego czytania książek. Prosta, nie zajmuje wiele miejsca, bez problemu zmieści się za ulubionym fotelem. Punktowe światło oprawy umożliwia dokładne oświetlenie wybranego elementu, a dostępna temperatura barwowa źródła światła – ciepła lub biała – pozwoli odpocząć oczom.

# RID FL1

IP 20 CE  

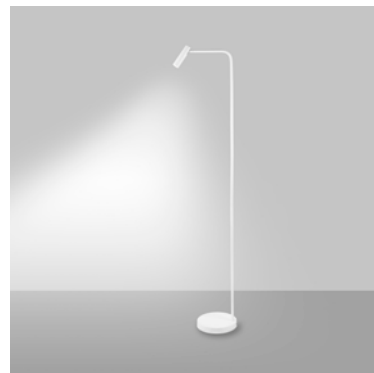

## Options

Opcje

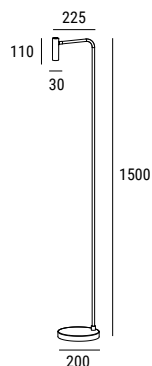

LED | 6W | 600lm |  
CRI ≥ 90 |  
weight/waga: 4,3kg |  
box/karton:  
250x250x1550mm |

F00020 . K C . L

## Finishes

Wykończenia



## Optics

Optyka

K	C	L
<b>Optics / Optyka</b>		
20 - 20°		
36 - 36°		
55 - 55°		
<b>Colour / Kolor</b>		
01 - white   biały		
02 - black   czarny		
03 - grey   szary		
04 - gold   złoty		
<b>Colour temperature / Temperatura barwowa</b>		
27 - 2700K		
30 - 3000K		
40 - 4000K		



20°



36°



55°

## BERO FL



The slim line of the Bero FL floor lamp will be liked by simplicity lovers. LEDs placed at the end of the long tube and a delicate spotlight fixed to its side, will allow you to play with the light in the room. The product is available in four colours, with a choice of optics and colour temperature.

Smukła linia podłogowej lampy Bero FL spodoba się miłośnikom prostoty. Oczka ledowe, umieszczone na końcu długiej tuby oraz delikatny reflektor przytwierdzony do jej boku, pozwolą ciekawie bawić się światłem w pomieszczeniu. Produkt dostępny w czterech kolorach, z możliwością wyboru optyki i temperatury barwowej.



# BERO FL

IP 20 CE  



## Options

Opcje

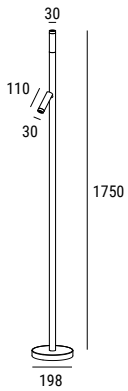

LED | 2x6W | 2x600lm |  
CRI ≥ 90 |  
weight/waga: 7kg |  
box/karton:  
210x210x1800mm |

F00010 . K C . L

## Finishes

Wykończenia



## Optics

Optyka

K	C	L
<b>Optics / Optyka</b>		
20 - 20°		
36 - 36°		
55 - 55°		
<b>Colour / Kolor</b>		
01 - white   biały		
02 - black   czarny		
03 - grey   szary		
04 - gold   złoty		
<b>Colour temperature / Temperatura barwowa</b>		
27 - 2700K		
30 - 3000K		
40 - 4000K		



20°



36°



55°



# JAGO

The Jago floor lamp will meet the expectations of those who seek original lighting for modern interiors. The sphere-shaped glass shade has been placed on a tripod providing good lamp stability. A round shelf located in the middle of the base height, which can be used as a handy table, also ensures perfect balance.

Lampa podłogowa Jago spełni oczekiwania tych, którzy poszukują oryginalnego oświetlenia do nowoczesnych wnętrz. Klosz w kształcie kuli został umieszczony na trójnogu zapewniającym dobrą stabilizację lampy. Idealne wyważenie zapewnia także okrągła półka znajdująca się w połowie wysokości podstawy, która może być używana jako podręczny stolik.

# JAGO

IP 20 CE  

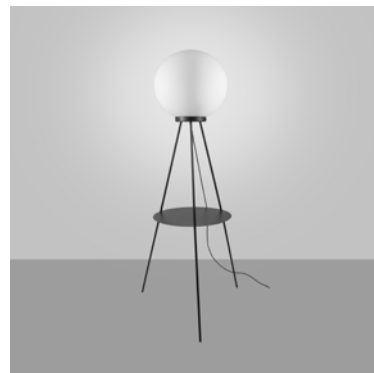

## Options

Opcje

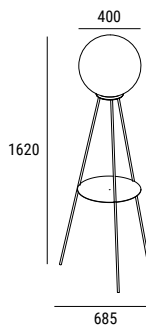

E27 | max 100W |  
weight/waga: 10kg |  
box/karton:  
700x700x1300 +  
420x420x420mm |

F00050.0 C . 0

## Finishes

Wykończenia

C

Colour / Kolor

01 - white | biały

02 - black | czarny

03 - grey | szary

04 - gold | złoty



01 white  
01 biały



03 grey  
03 szary



02 black  
02 czarny



04 gold  
04 złoty



## SUN FL1

Sun FL1 standing lamp, thanks to its minimalist design, will prove itself in modern and industrial style interiors. Its raw form is broken by a perfectly round lamp shade, under which there is a LED light source. The Sun lamp is available in four finishes.

Lampa stojąca Sun FL1 poprzez swój minimalistyczny design, sprawdzi się we wnętrzach w stylu nowoczesnym i industrialnym. Surową formę przełamuje okrągły klosz, pod którym kryje się źródło światła LED. Lampa Sun jest dostępna w czterech wykończeniach.

# SUN FL1

IP 20 CE  



## Options

Opcje

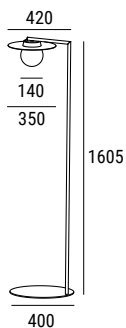

LED | 8W | 500lm |  
CRI ≥ 90 |  
weight/waga: 10kg |  
box/karton:  
440x440x1700 +  
160x160x160mm |

F00070 . 0 C . 0

## Finishes

Wykończenia

**K** **C**

Colour / Kolor

01 - white | biały

02 - black | czarny

03 - grey | szary

04 - gold | złoty

Colour temperature / Temperatura barwowa

27 - 2700K

30 - 3000K

40 - 4000K



01 white  
01 biały



03 grey  
03 szary



02 black  
02 czarny



04 gold  
04 złoty



**outdoor / zewnętrzne**



# LINE

LINE- external profile, we can professionally illuminate the facade of a given facility. LED embedded in a silicon, milky housing for linear lighting. The applied profile is resistant to weather conditions such as rain, UV radiation or high temperatures. Ingress protection IP67.

LINE- profil zewnętrzny, dzięki któremu możemy w profesjonalny sposób oświetlić elewację danego obiektu. LED zatopiony w silikonowej, mlecznej obudowie do oświetlenia liniowego. Zastosowany profil jest odporny na działanie czynników atmosferycznych, takich jak deszcz, promieniowanie UV, czy wysokie temperatury. Klasa szczelności IP67.



# LINE

IP67 CE 



## Options

Opcje

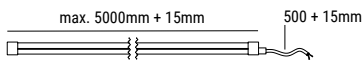

**P144** E . K

light module/moduł świetlny

LED | 7,2W/m | 510lm |

CRI ≥ 90 |

weight/waga: 1,3kg |

□ | 15  
15

## Accessories

Akcesoria

**E** | **K**

Colour temperature / Temperatura  
barwowa

27 - 2700K

30 - 3000K

40 - 4000K

Electronics / Elektronika

O - ON/OFF

D - DALI

C - CASAMBI



profile  
profil



end cap  
zaślepka

	code/kod
profile/profil 1000x18x19mm	P1451
end cap (2 pcs.)/zaślepka (2szt.)	P146.01
power supply/zasilacz IP65 75W 24V DC	P146.02
power supply/zasilacz IP65 100W 24V DC	P146.03
power supply/zasilacz IP65 150W 24V DC	P146.04
power supply/zasilacz IP65 200W 24V DC	P146.05
power supply/zasilacz IP65 240W 24V DC	P146.06



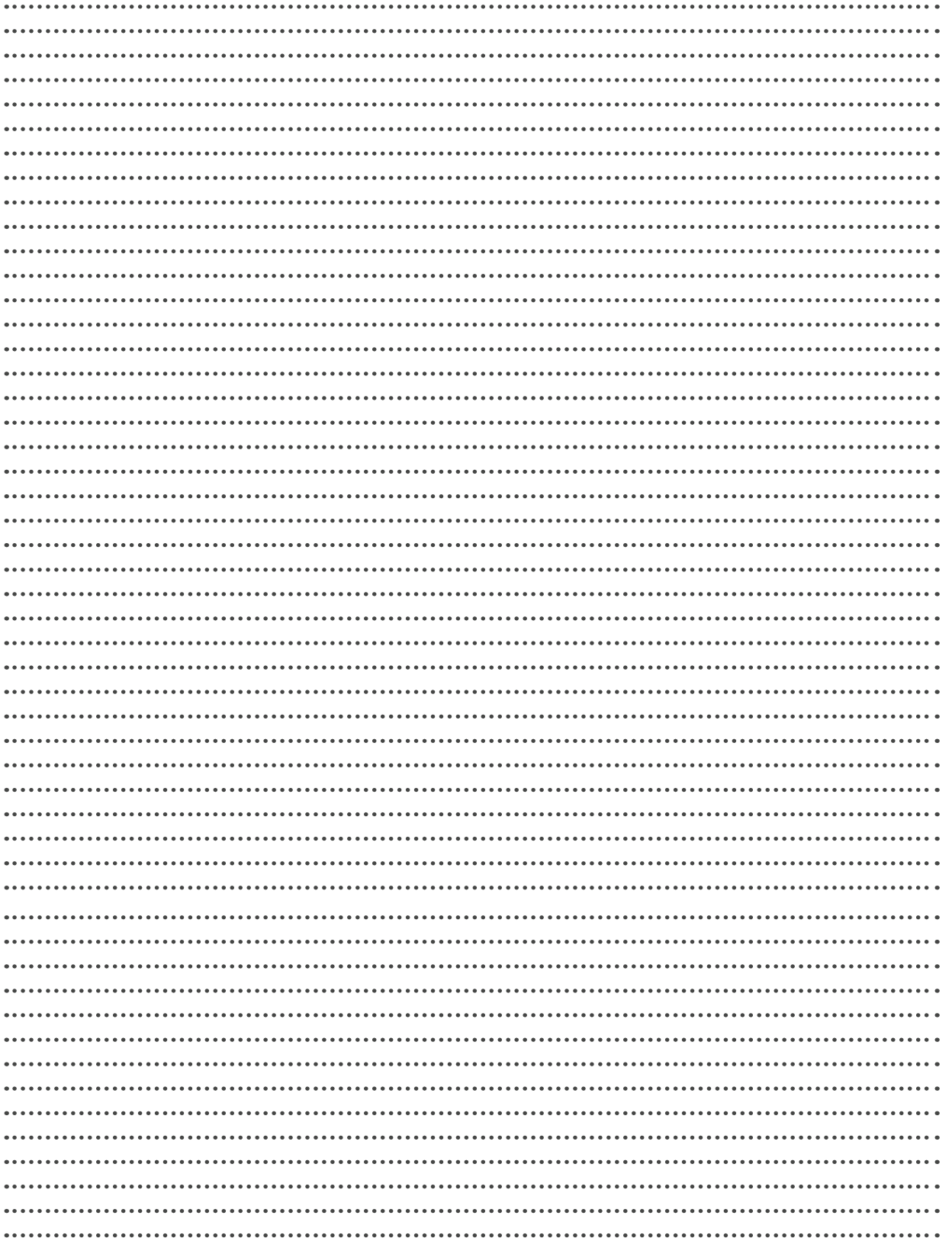



[www.zaho.pl](http://www.zaho.pl)



**ZAHO**<sup>®</sup>  
LIGHTING

**NOVELTIES  
2024**

# Jetson family

The Jetson luminaire family is a fusion of design and functionality. Characteristic of the Jetson luminaires is their innovative design, where a light tube enclosed in a tube serves as the main light diffusing element. This solution provides extraordinary uniformity and softness of light, eliminating shadow effects. The variety of Jetson luminaire options allows for creative construction of light constellations that can be tailored to the individual needs and preferences of users. From single tubes to their multiplication, the possibilities are practically limitless. As a result, unique lighting compositions can be created that not only illuminate the room but also serve as a decorative element, adding character and depth to the space.

Rodzina opraw Jetson to symbioza designu oraz funkcjonalności. Charakterystyczna dla opraw Jetson jest ich innowacyjna konstrukcja, w której zamknięty w tubie wąż świetlny pełni rolę głównego elementu rozpraszającego światło. To rozwiązanie zapewnia niezwykłą równomierność i miękkość oświetlenia, eliminując efekty zacielenia. Różnorodność wariantów opraw Jetson pozwala na kreatywne budowanie konstelacji świetlnych, które mogą być dostosowane do indywidualnych potrzeb i preferencji użytkowników. Od pojedynczych tub po ich multiplikacje, możliwości są praktycznie nieograniczone. W rezultacie można tworzyć unikalne kompozycje świetlne, które nie tylko oświetlają pomieszczenie, ale także stanowią element dekoracyjny, dodając charakteru i głębi przestrzeni.

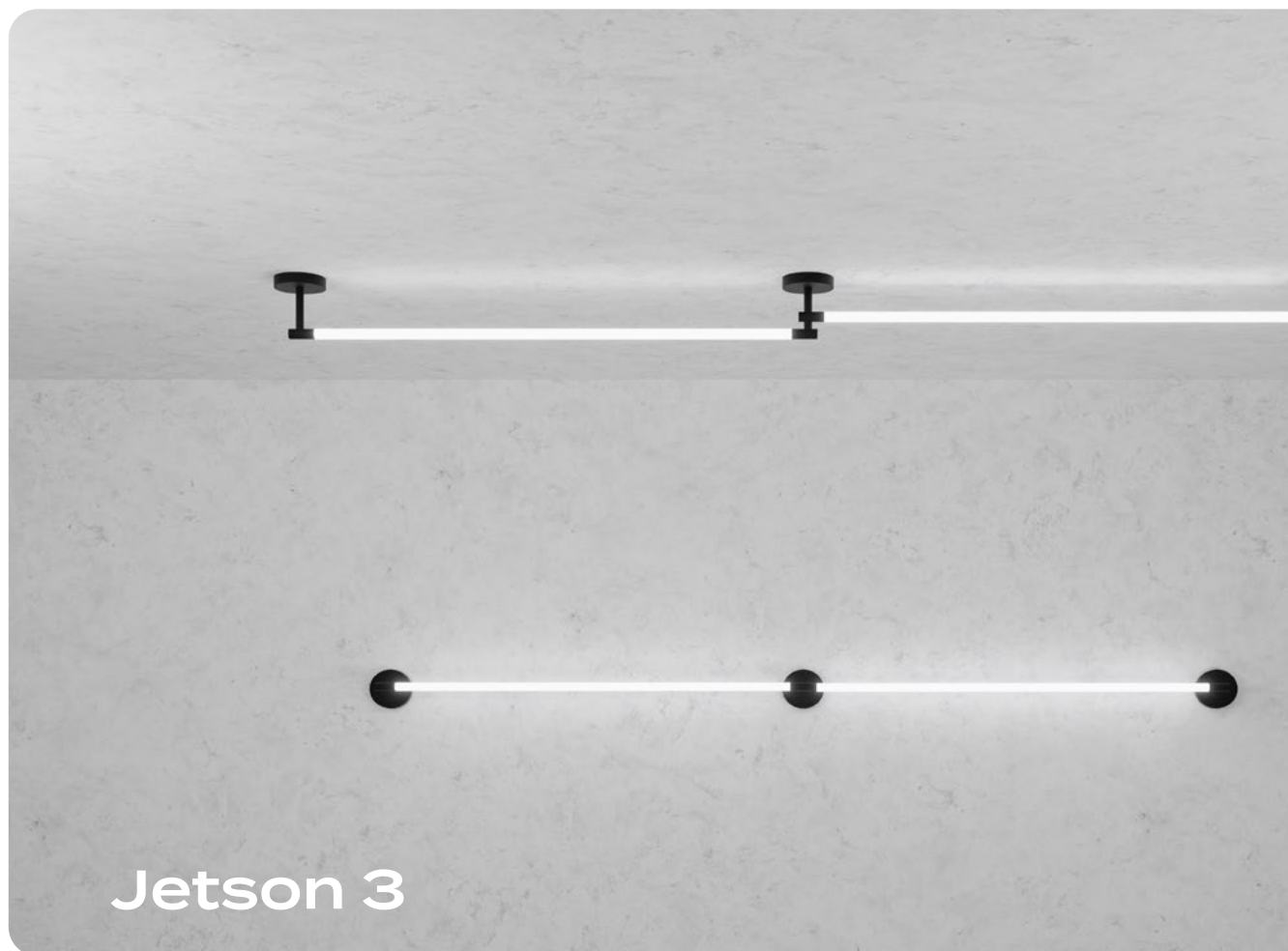

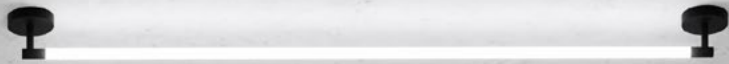

Jetson 2



Jetson 4







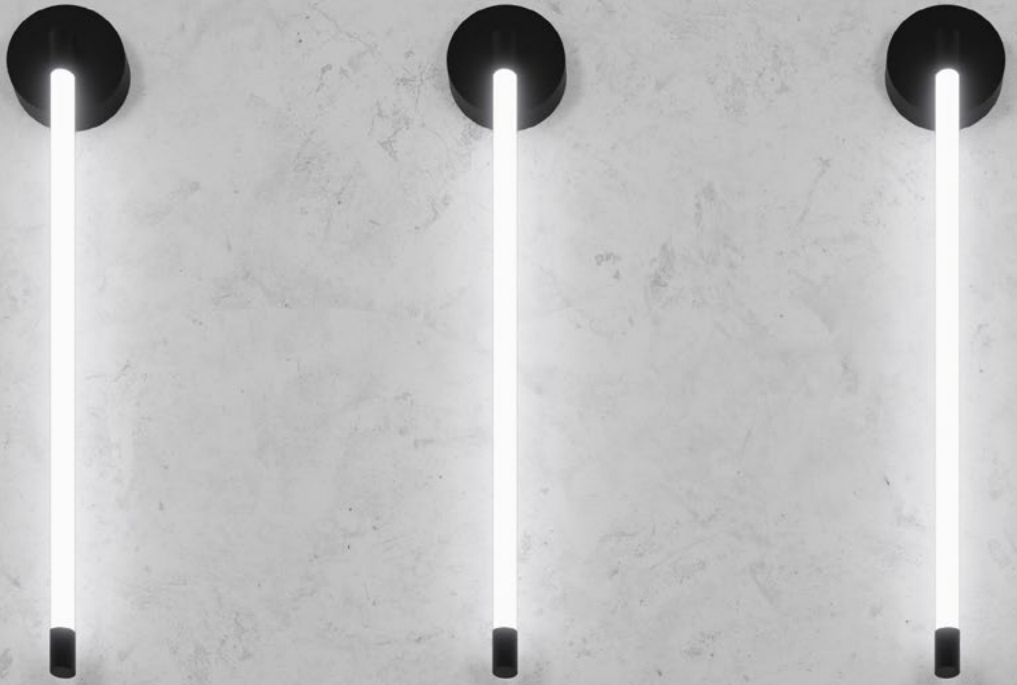

Jetson wall

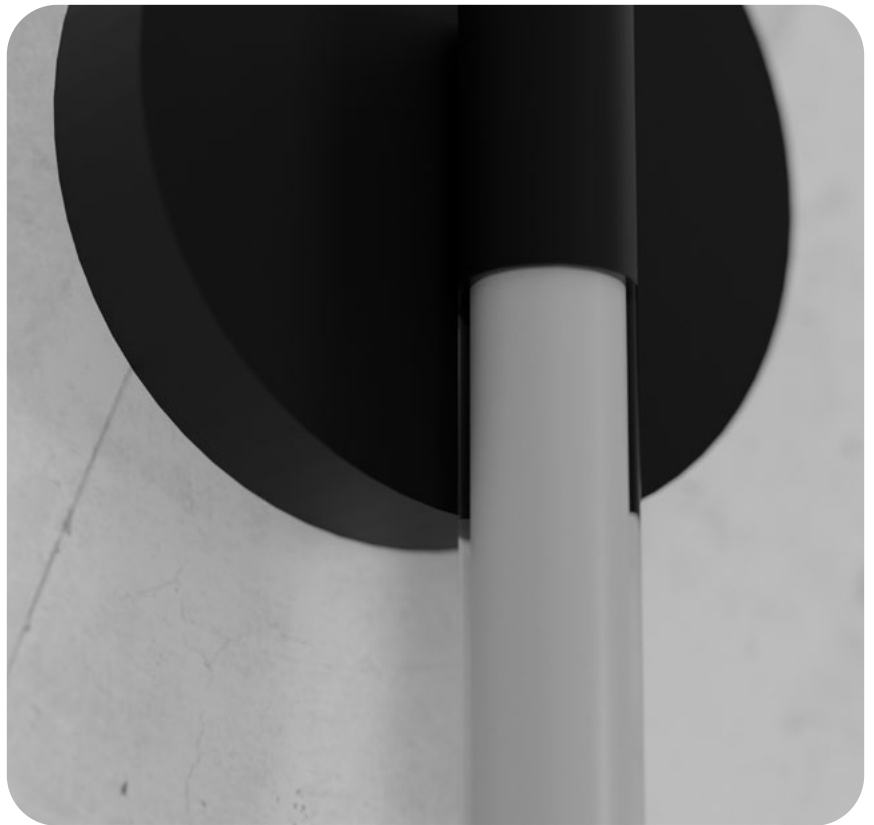



## Jetson line 1

1000mm  
1500mm  
2000mm

## Jetson line 2

1000mm  
1500mm  
2000mm

Jetson line 1  
recessed



Jetson line 2  
ceiling





interior design:  
Marcin Jabłoński Studio





Noah

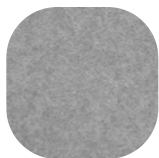
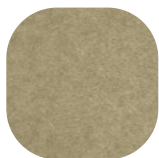
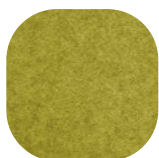
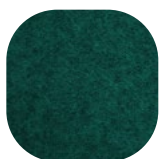

## family of acoustic luminaires

The family of acoustic luminaires is not only lighting luminaires providing very good light distribution but also an innovative solution caring for the acoustics of the space. The luminaires have been equipped with a special acoustic element that helps effectively reduce sound reverberation, possesses sound-absorbing properties, and allows for absorbing sound waves in a given room. They will work perfectly in both residential spaces and offices. The availability of the material in various color variants makes it easy to match the luminaires to a particular space.

Rodzina opraw akustycznych to nie tylko oprawy oświetleniowe zapewniające bardzo dobrą dystrybucję światła, ale także innowacyjne rozwiązanie dbające o akustykę przestrzeni. Oprawy zostały wyposażone w specjalny element akustyczny, pomagający skutecznie redukować pogłos dźwięku, posiada właściwości pochłaniania dźwięku oraz pozwala absorbować fale dźwiękowe w danym pomieszczeniu. Doskonale sprawdzą się zarówno w przestrzeniach mieszkalnych, jak i w biurach. Dostępność materiału w różnych wariantach kolorystycznych pozwala łatwo dopasować oprawy do danej przestrzeni.

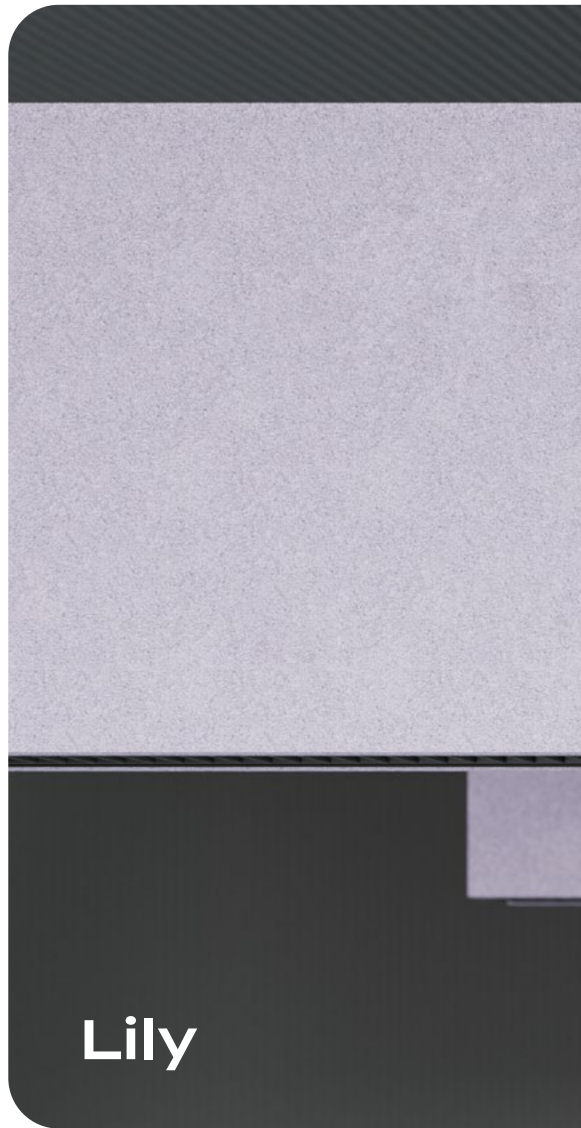
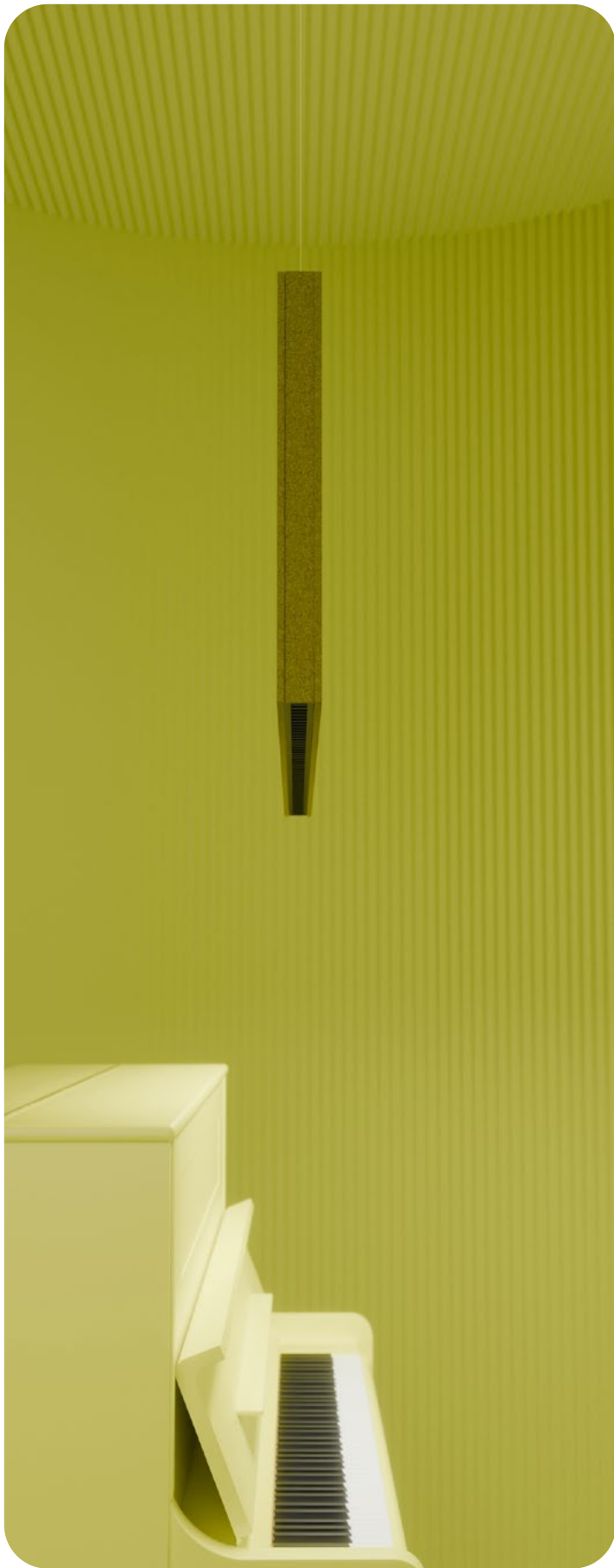

Lily





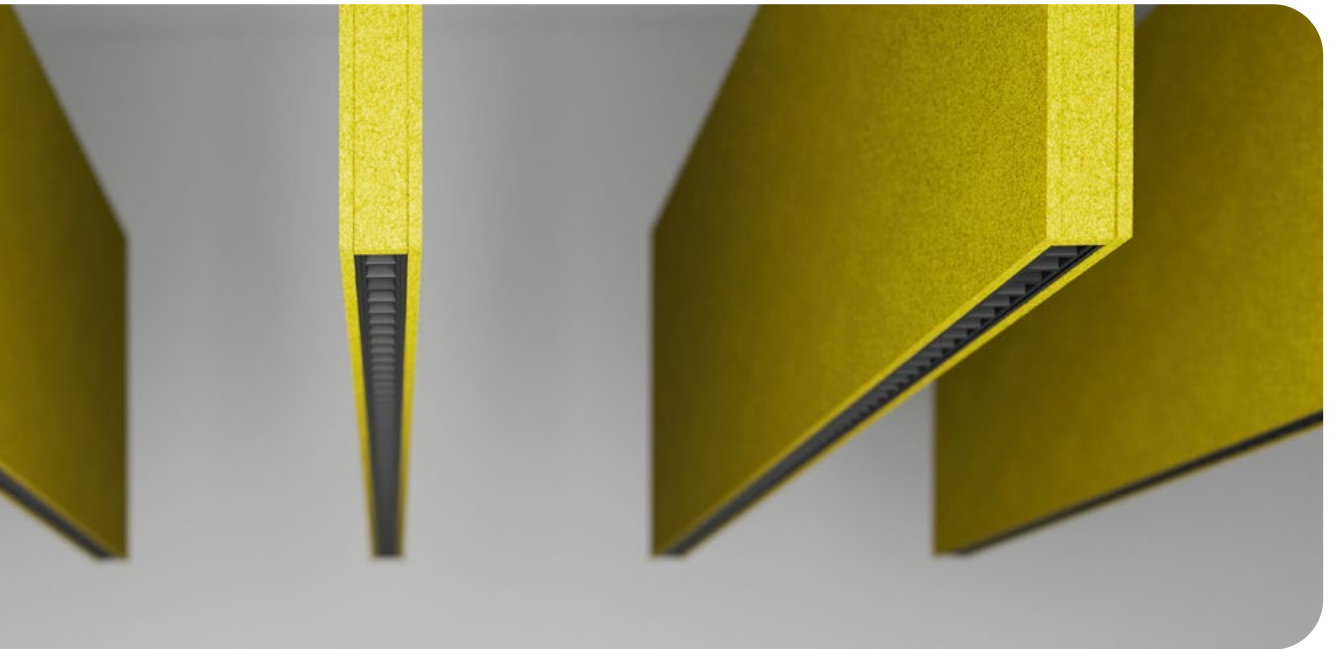
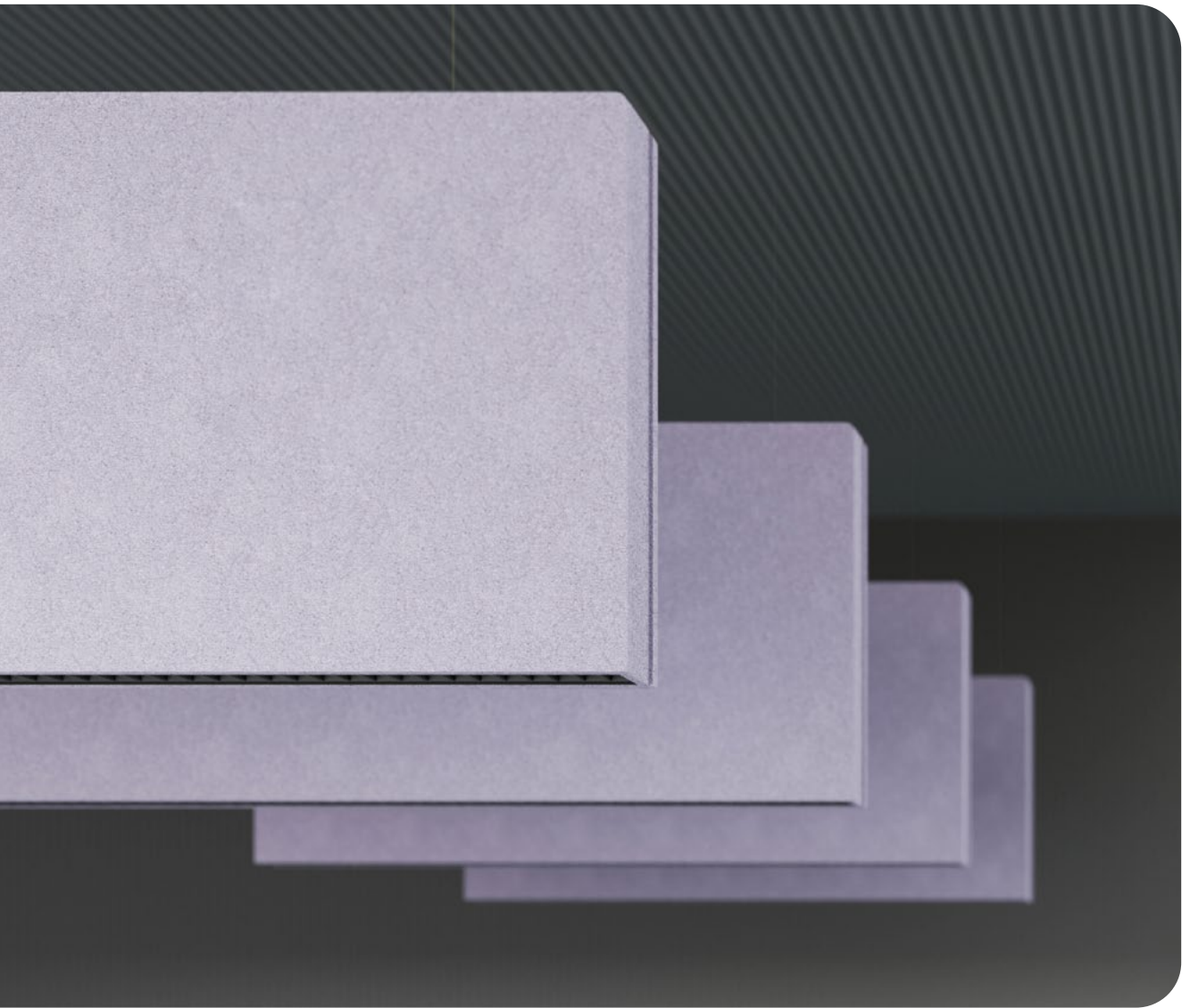

# family of acoustic luminaires

The family of acoustic luminaires is not only lighting luminaires providing very good light distribution but also an innovative solution caring for the acoustics of the space. The luminaires have been equipped with a special acoustic element that helps effectively reduce sound reverberation, possesses sound-absorbing properties, and allows for absorbing sound waves in a given room. They will work perfectly in both residential spaces and offices. The availability of the material in various color variants makes it easy to match the luminaires to a particular space.

Rodzina opraw akustycznych to nie tylko oprawy oświetleniowe zapewniające bardzo dobrą dystrybucję światła, ale także innowacyjne rozwiązanie dbające o akustykę przestrzeni. Oprawy zostały wyposażone w specjalny element akustyczny, pomagający skutecznie redukować pogłos dźwięku, posiada właściwości pochłaniania dźwięku oraz pozwala absorbować fale dźwiękowe w danym pomieszczeniu. Doskonale sprawdzą się zarówno w przestrzeniach mieszkalnych, jak i w biurach. Dostępność materiału w różnych wariantach kolorystycznych pozwala łatwo dopasować oprawy do danej przestrzeni.

## Sun SD1

The inconspicuously simple structure of the Sun SD1 lamp attracts attention in an amazing way. It is perfect for various types of rooms. Its simplicity makes it a great addition in the living room, restaurant or office. It is available in four colour variants.

Niepozornie prosta budowa lampy Sun SD1 w zadziwiający sposób przykuwa uwagę. Znakomicie sprawdzi się w pomieszczeniach różnego rodzaju. Jej prostota sprawia, że bez problemu stanie się świetnym dodatkiem zarówno w salonie, jak i restauracji czy biurze. Jest dostępna w czterech wariantach kolorystycznych.

## Shadow

Shadow is the answer for people who value simplicity in lighting. Light, circle-shaped body with a flexible tube in it, with no visible mounting elements. Delicate light emitted from the luminaire directly illuminates the space in which it is located. The luminaire is available in two diameters  $\varnothing 500\text{mm}$  and  $\varnothing 900\text{mm}$

Shadow to odpowiedź dla osób ceniących prostotę w oświetleniu. Lekki korpus w kształcie koła w którym umieszczona została elastyczna tuba bez widocznych elementów montażowych. Delikatne światło wydobywające się z oprawy w sposób bezpośredni oświetla przestrzeń w której się znajduje. Oprawa występuje w dwóch średnicach  $\varnothing 500\text{mm}$  i  $\varnothing 900\text{mm}$ .





## Luna WL3

Luna WL3 was created with modern interiors in mind. It is a great solution for people who want to create an elegant and original space in their own home. Luna is an eye-catcher. The lamp looks great on its own and also in combination with other lamps.

Luna WL3 została stworzona z myślą o nowoczesnych wnętrzach. To świetne rozwiązanie dla osób, które pragną stworzyć elegancką i oryginalną przestrzeń we własnym domu. Luna przyciąga wzrok. Lampa doskonale wygląda w pojedynkę, a także w połączeniu z innymi lampami.

## Star SD

The Star SD lamp, which will work perfectly in any interior. It will ideally fill modern spaces and give them an original feel. It has the shape of a circle, which looks perfect on its own and also with other lamps. Star will create an unprecedented decoration in every house, even when it is switched off.

Lampa Star SD, która doskonale sprawdzi się w każdym wnętrzu. Idealnie wypełni nowoczesne przestrzenie i nada im oryginalnego wydźwięku. Ma kształt okręgu, który doskonale wygląda w pojedynkę, a także z innymi lampami. Star stworzy niespotykaną dekorację w każdym domu, nawet kiedy będzie wyłączona.



# Mesmo

Mesmo is a unique lighting luminaire that utilizes a flexible light tube to build new lighting solutions. Thanks to its flexible construction, Mesmo easily adapts to various spaces, offering unlimited possibilities for creating unique lighting compositions. Available in lengths of 5 and 10 meters and in two types of mounting: surface-mounted and suspended, Mesmo is a significant design element that adds a new dimension to designed spaces. Its flexibility allows for creating intriguing light shapes and patterns that can be tailored to the individual needs and preferences of customers. Regardless of the type or purpose of the room, Mesmo offers versatility and functionality that allow you to highlight and emphasize the character of any space. With the possibility of both surface-mounted and suspended installation, Mesmo can be used in rooms with standard heights as well as those with unconventional dimensions or architecture. It's not just lighting—it's a creative tool that inspires experimentation and the creation of unique lighting atmospheres.

Mesmo to wyjątkowa oprawa oświetleniowa, która wykorzystuje elastyczną tubę świetlną do budowania nowych rozwiązań oświetleniowych. Dzięki swojej elastycznej konstrukcji, Mesmo bez trudu dostosowuje się do różnorodnych przestrzeni, oferując nieograniczone możliwości tworzenia unikatowych kompozycji świetlnych. Dostępna w długościach 5 i 10 metrów oraz w dwóch rodzajach montażu: nastropowym i zwieszanym, Mesmo stanowi istotny element projektowy, który nadaje nowy wymiar projektowanym przestrzeniom. Jego elastyczność pozwala na tworzenie intrygujących kształtów i wzorów świetlnych, które mogą być dostosowane do indywidualnych potrzeb i preferencji klientów. Bez względu na rodzaj pomieszczenia czy jego przeznaczenie, Mesmo oferuje wszechstronność i funkcjonalność, które pozwalają wyeksponować i podkreślić charakter każdej przestrzeni. Dzięki możliwościom montażu nastropowego i zwieszanego, Mesmo może być wykorzystywany zarówno w pomieszczeniach o standardowej wysokości, jak i tych o nietypowych wymiarach czy architekturze. To oświetlenie, które nie tylko zapewnia niezbędne światło, ale także staje się integralną częścią aranżacji, dodając niepowtarzalnego uroku i wyjątkowego charakteru każdej przestrzeni. Mesmo to nie tylko oświetlenie - to kreatywne narzędzie, które inspirowane do eksperymentowania i kreowania unikalnych atmosfer świetlnych.

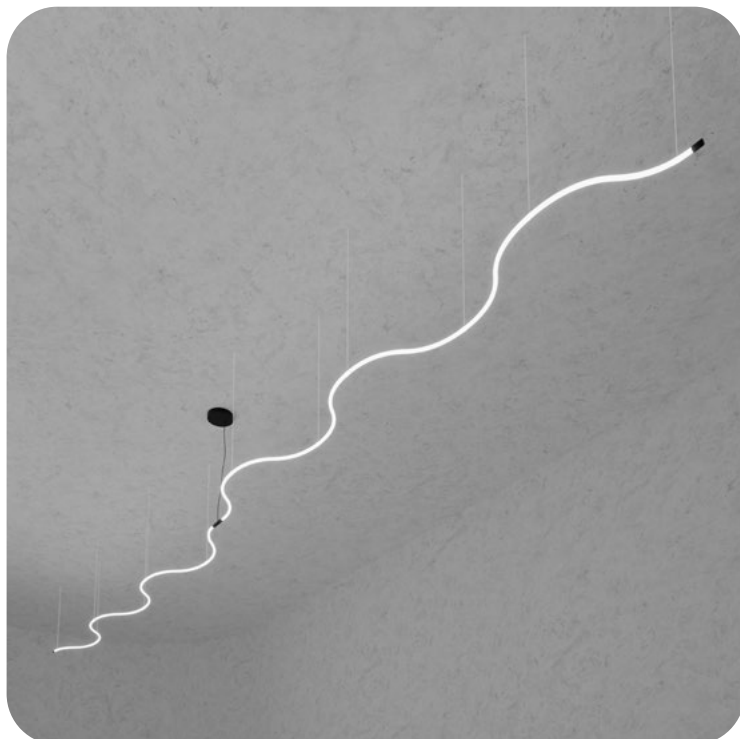
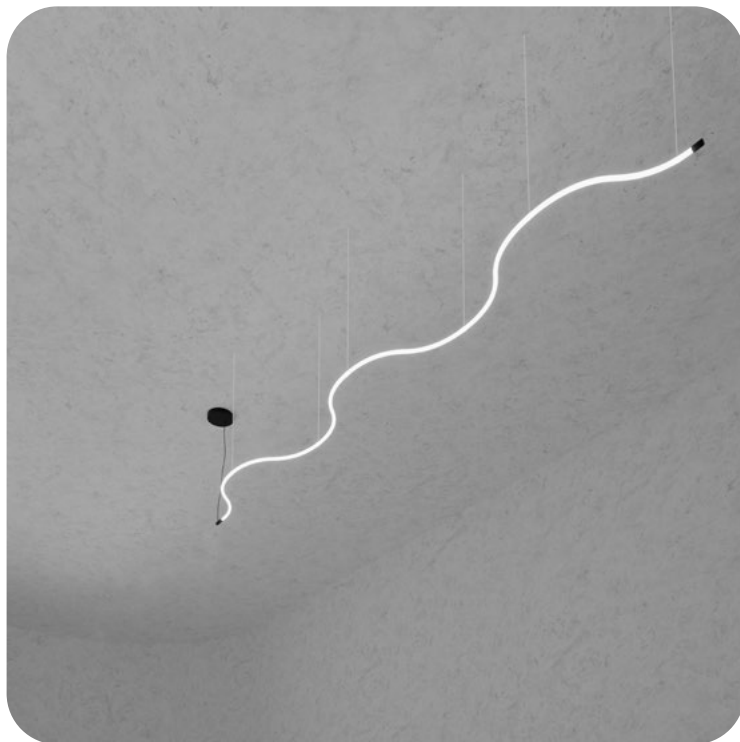







Vistula, Kraków  
interior design: Schwitzke Górski

**Mesmo  
wall/ceiling 1**

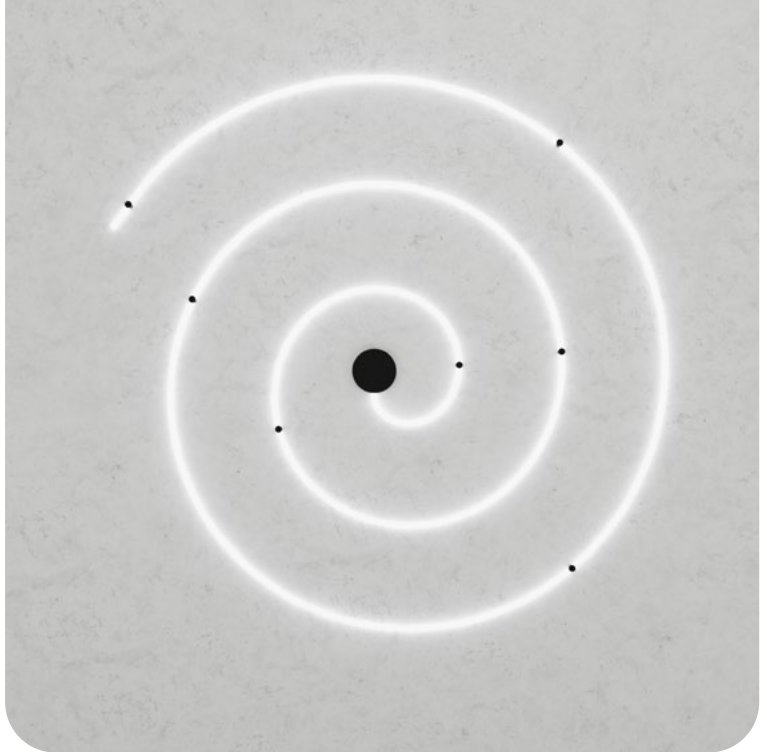

**Mesmo  
wall/ceiling 2**

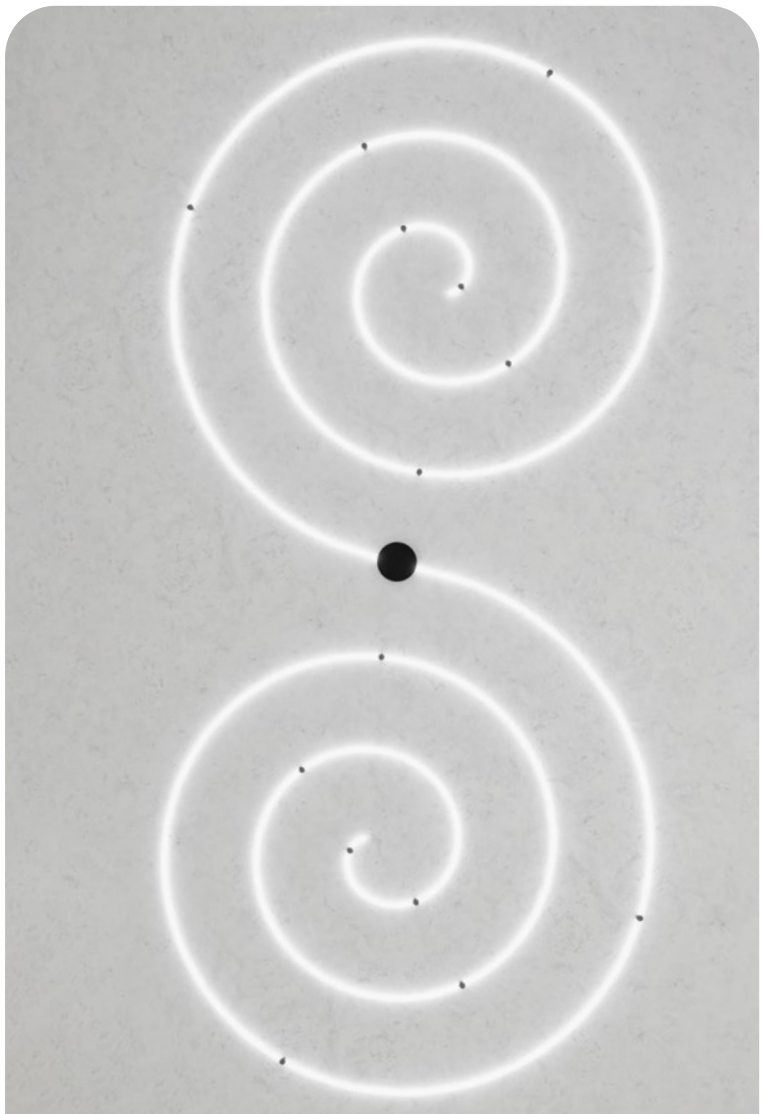





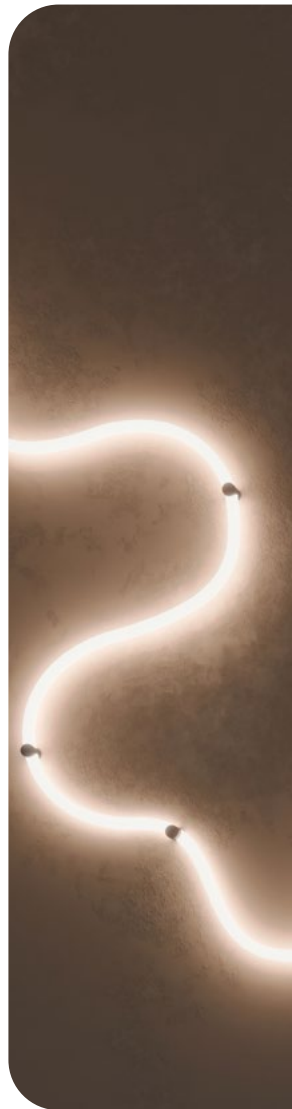

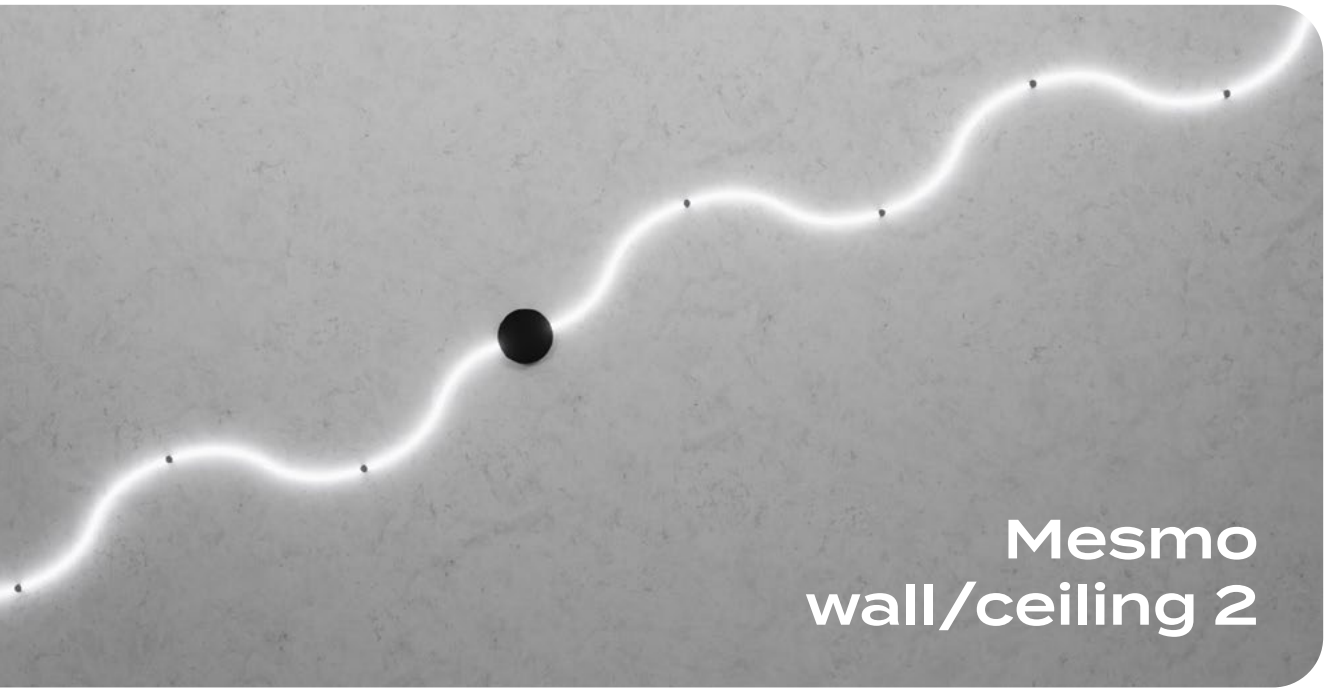

Mesmo  
wall/ceiling 2

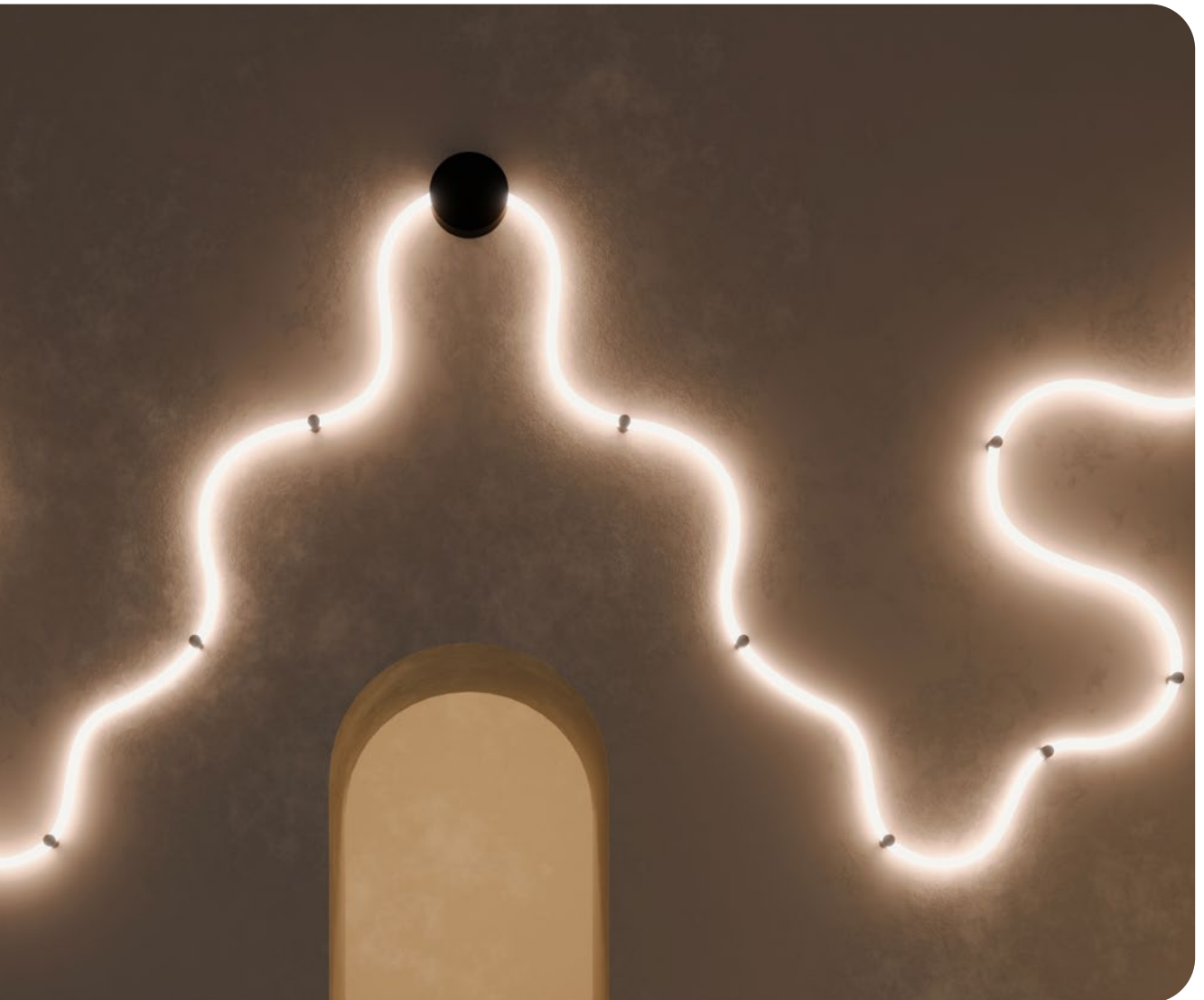

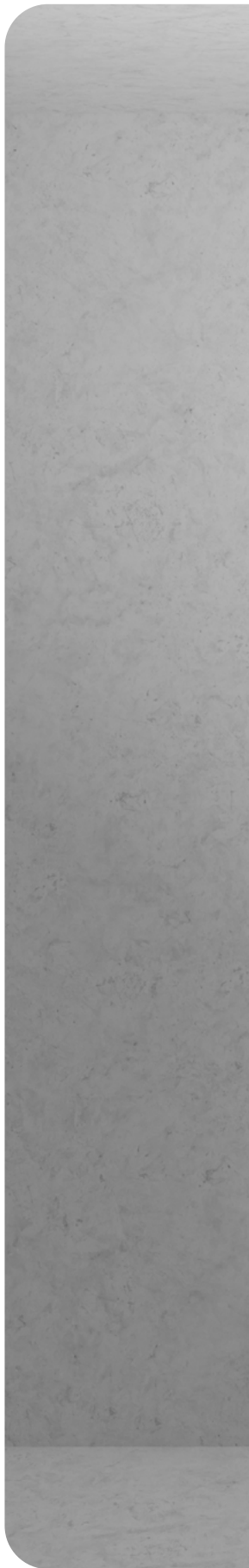

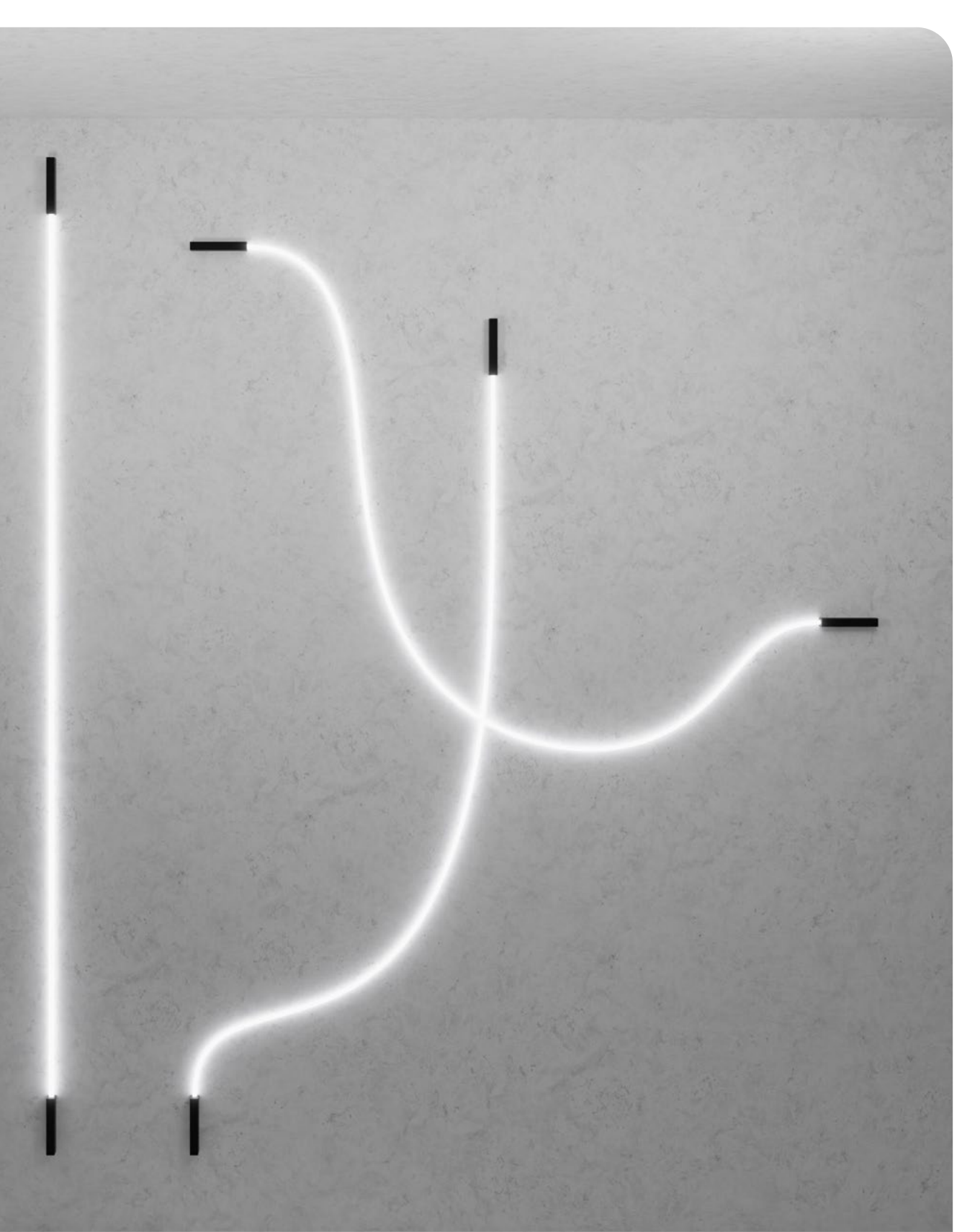

Mesmo wall 3



**Spritzer long**

# Spritzer

Spritzer is a lamp with dynamic, fluid shapes. Enclosed in a flexible light tube, the light gently spreads along defined lines. The luminaire focuses on playing with shadows. Thanks to its irregular shapes, it can give the interior a unique atmosphere. An additional feature is the possibility of using Tunable White technology in the luminaire. The natural color change that light undergoes during the day serves as a model for this technology. To best replicate natural daylight, the light is mixed by cold and warm white LED diodes, covering the entire range from 2700 to 6500 kelvins. Research has shown that cold white light with a high blue component stimulates activity and concentration, while warm white light calms down. As a result, Spritzer luminaires are characterized not only by an interesting, unique design, but through the use of the aforementioned technology, they create an environment that naturally supports people. It helps to create perfect conditions for both relaxation and work.

Spritzer to lampa o dynamicznych, płynnych kształtach. Zamknięte w elastycznej tubie światło rozchodzi się delikatnie wzdłuż wyznaczonych linii. Oprawa stawia na zabawę cieniami. Dzięki nieregularnym kształtom może nadać wnętrzu nietypowy klimat. Dodatkową funkcją jest możliwość zastosowania w oprawie technologii Tunable White. Naturalna zmiana koloru, której ulega światło w ciągu dnia, służy za wzór dla tej technologii. Aby jak najlepiej odwzorować naturalne światło dzienne, światło jest mieszane przez zimne i ciepłe białe diody LED, obejmujące cały zakres od 2700 do 6500 kelwinów. Badania wykazały, że zimne białe światło z wysokim udziałem barwy niebieskiej pobudza do aktywności i sprzyja koncentracji, podczas gdy ciepłe białe światło uspokaja. Dzięki temu oprawy Spritzer charakteryzują się nie tylko ciekawym, unikatowym designem, ale poprzez zastosowanie w/w technologii tworzy środowisko, które w naturalny sposób wspiera ludzi. Pomaga stworzyć doskonałe warunki zarówno do odpoczynku jak i do pracy.



Spritzer medium







# Bricks

The Bricks lighting luminaires family combines design, functionality, original form, and modernity. Simple constructions complemented by one common element - a glowing tube - allow for creating fixtures ideal for any space. The softly curved geometry of light is freely suspended, giving the luminaires a sense of lightness and delicacy. The Bricks collection will perfectly fill modern spaces and give them an original tone. An additional feature is the possibility of using Tunable White technology in the luminaire. The natural color change that light undergoes during the day serves as a model for this technology. To best replicate natural daylight, the light is mixed by cold and warm white LED diodes, covering the entire range from 2700 to 6500 kelvins. Research has shown that cold white light with a high blue component stimulates activity and concentration, while warm white light calms down. As a result, Bricks luminaires are characterized not only by an interesting, unique design, but through the use of the aforementioned technology, they create an environment that naturally supports people. It helps to create perfect conditions for both relaxation and work. Luminaire design: Studio Politowicz.

Rodzina opraw oświetleniowych Bricks łączy w sobie design, funkcjonalność, oryginalną formę i nowoczesność. Proste konstrukcje uzupełnione o jeden wspólny element – świecąca tubę – pozwalają na tworzenie opraw idealnych dla każdej przestrzeni. Miętko zakrzywiona geometria światła zostaje swobodnie zwieszona co nadaje oprawom lekkości i delikatności. Kolekcja opraw Bricks idealnie wypełni nowoczesne przestrzenie i nada im oryginalnego wydźwięku. Dodatkową funkcją jest możliwość zastosowania w oprawie technologii Tunable White. Naturalna zmiana koloru, której ulega światło w ciągu dnia, służy za wzór dla tej technologii. Aby jak najlepiej odwzorować naturalne światło dzienne, światło jest mieszane przez zimne i ciepłe białe diody LED, obejmujące cały zakres od 2700 do 6500 kelwinów. Badania wykazały, że zimne białe światło z wysokim udziałem barwy niebieskiej pobudza do aktywności i sprzyja koncentracji, podczas gdy ciepłe białe światło uspokaja. Dzięki temu oprawy Bricks charakteryzują się nie tylko ciekawym, unikatowym designem, ale poprzez zastosowanie w/w technologii tworzy środowisko, które w naturalny sposób wspiera ludzi. Pomaga stworzyć doskonałe warunki zarówno do odpoczynku jak i do pracy. projekt: Studio Politowicz













Marcin Jabłoński Studio



Kubika

